

CLOUD Headphone Distribution System

- CAMI6 Audio Distribution Matrix
- CASI6 Audio Distribution Sub-Station
- RH-8 Headphone Station
- WP-8 Wall Panel

482.6mm / 19"



88.0mm / 3 1/2"

Cloud CAMI6 front view



Cloud CAMI6 rear view

482.6mm / 19"



88.0mm / 3 1/2"

Cloud CASI6 front view



Cloud CASI6 rear view



RH-8 front view

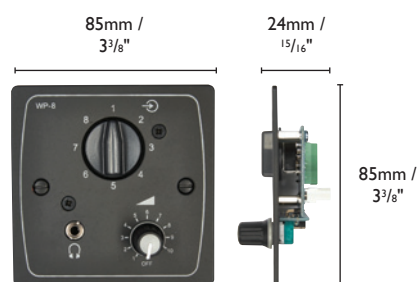

WP-8 front and side view
Also available in white

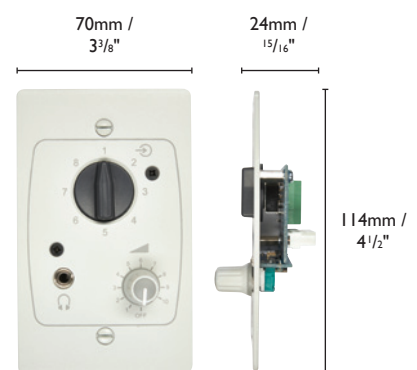

WP-8A front and side view
Also available in black

General Description

The Cloud Headphone Distribution System is able to provide stereo headphone feeds for up to 256 users, with each user able to individually select their own programme (from a choice of up to eight), and to set their own volume.

It is ideal for installation in fitness centres, treatment rooms, waiting rooms; for multi-language applications in museums and galleries, or any situation where a number of users need to be offered a choice of music track or commentaries. Interconnection between the base unit(s) and the remote headphone stations is via standard CAT-5 cabling, making installation very simple.

The system is based on the 2U rack-mounting CAM-16 audio matrix, which can feed 16 headphone stations. It has line inputs for eight stereo programme sources and a separate balanced priority input, which can be used for general paging, announcements or emergency messages. The unit has rear panel preset gain controls for each line input, enabling the various programme sources to be balanced for equal volume. Output 16 is also available as a mono balanced line output, for connection to an external power amplifier driving a room speaker system. An external Music Mute input is provided, allowing the system to be interfaced to a BMS or Fire Control system to meet Local Authority regulations. All controls and connectors are on the rear panel to prevent inadvertent tampering.

CAM-16:

- Stereo audio matrix with eight line inputs
- Outputs for sixteen headphone stations
- Global input with priority override
- Short-to-ground access port for global input
- Gain controls for all inputs
- LED signal level indicators for easy balancing of line inputs
- Output 16 also available as a balanced mono feed
- Music Mute control input for interface with emergency systems
- Connects to headphone stations via CAT-5 cable and RJ45 connectors
- No front panel controls

CAS-16:

- Expansion unit for CAM-16
- Outputs for sixteen headphone stations
- No front panel controls

Two models of remote headphone station are available: the RH-8, which is designed for direct attachment to the frame of a fitness machine, and the WP-8, which is designed for installation in a standard UK-style single-gang electrical back box. An alternative version of the latter, the WP-8A, is also available; this is operationally identical, but fits a standard US-style electrical back box. Both the RH-8 and WP-8 feature an 8-position rotary source selector switch, a volume control, and a 3.5 mm stereo jack socket for connection of the user's headphones. Cloud recommend the Model CP32 headphones for use with the system. On the WP-8, the audio outputs are also available on a rear connector; and these can be used for driving a pair of small, low-power loudspeakers directly, or to provide a feed for a pair of active speakers or an external power amplifier. The external output can be wired so that it is either continuous, or interrupted when a pair of headphones is connected.

If more than 16 headphone stations are needed in the system, up to 15 CAS-16 sub-stations can be added. The CAS-16 is a 2U rack-mounting "slave" unit, which connects to the CAM-16 via a multi-core cable. Additional units are simply "daisy-chained" as required. Each CAS-16 unit can drive 16 headphone stations, with exactly the same facilities as those connected to the CAM-16.

RH-8:

- Remote headphone station for mounting on fitness machines, or other surfaces.
- Stereo headphone output
- Source selection switch
- Volume control
- Simple system connection with standard CAT-5/RJ45 cables

WP-8/WP-8A:

- Remote headphone station for permanent wall mounting
- Stereo headphone output
- Source selection switch
- Volume control
- Additional outputs for driving speakers or providing a line output feed
- External outputs may be continuous or mute when headphones are connected

Block Diagram

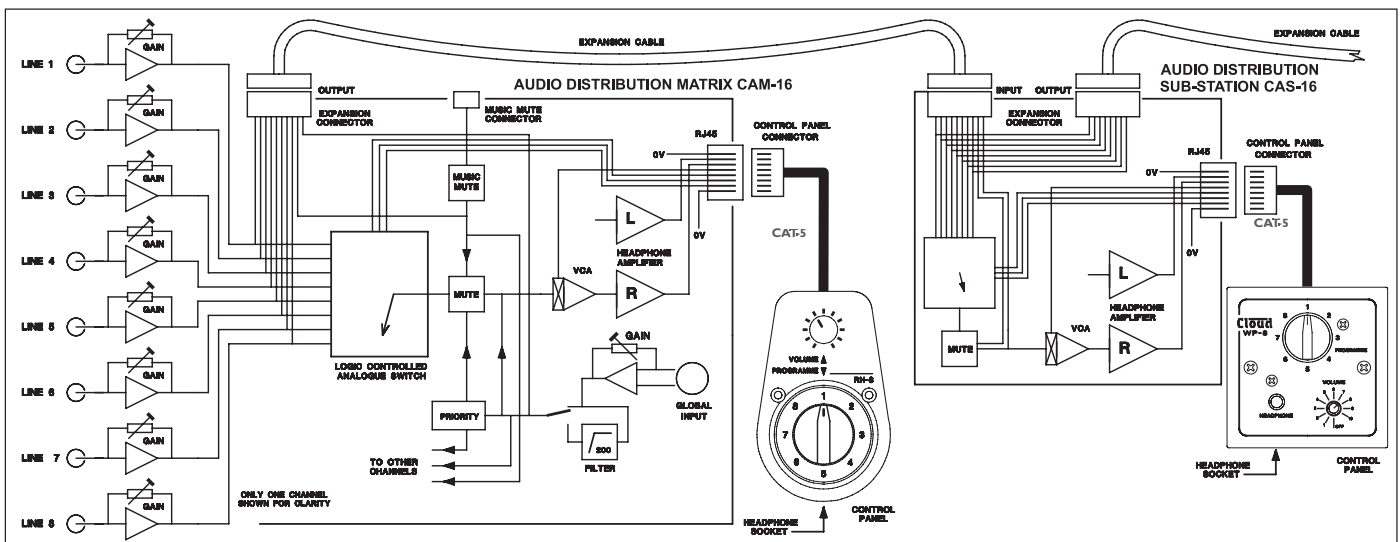

System Example

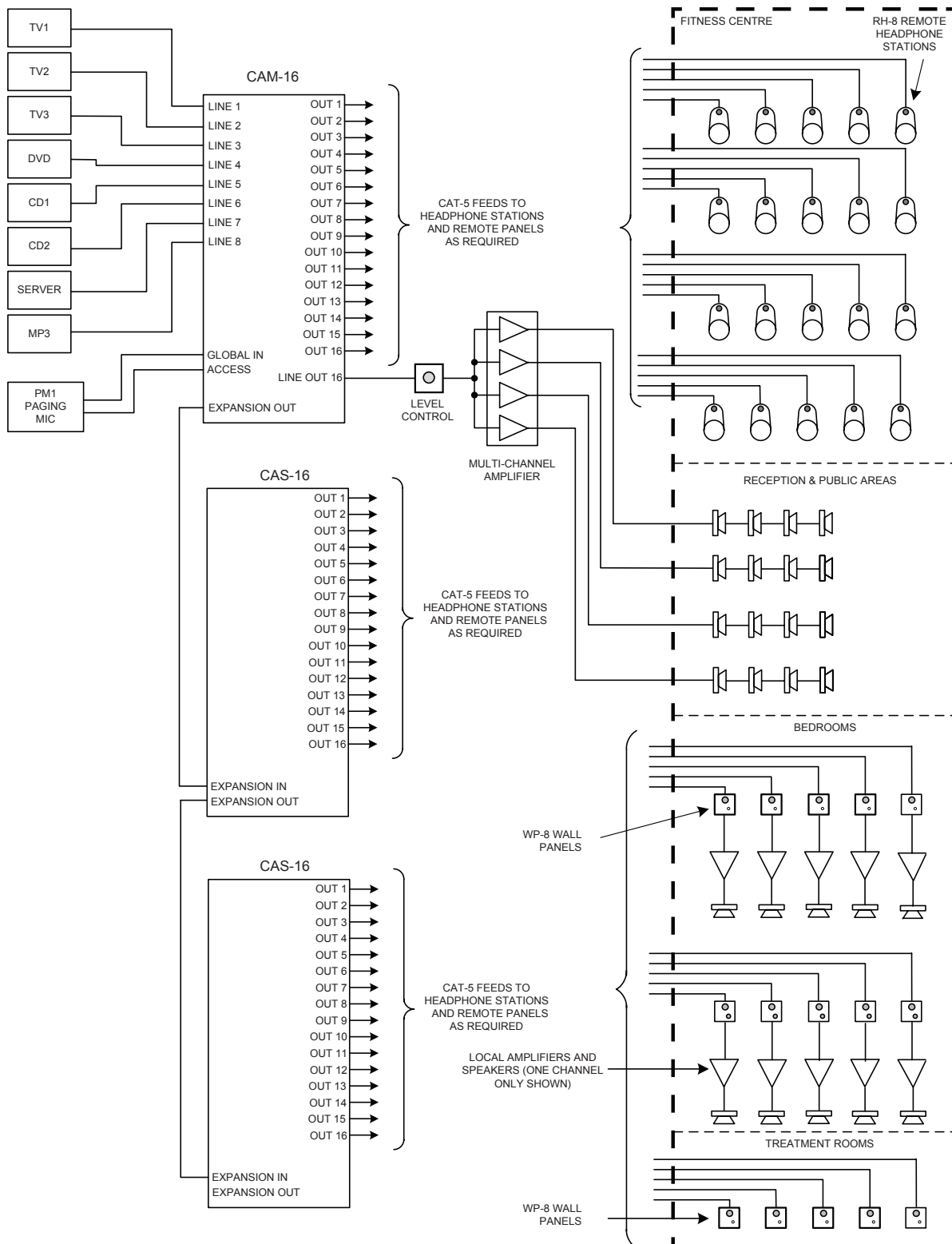

The example shown uses a CAM-16 distribution matrix and two CAS-16 expansion units to produce a total of 48 outputs. Each of these may be routed to an RH-8 remote headphone station or a WP-8 wall panel as required, anywhere in the building. Each RH-8/WP-8 will have individual selection of audio source and volume control.

The WP-8 installations in the bedrooms are shown with local amplifiers and loudspeakers connected; these would be wired to the “non-continuous” outputs of the WP-8s, so that users could plug their own headphones in, muting the speakers.

The paging mic connected to the Global input on the CAM-16 can be used to page to all the receiving stations simultaneously.

Technical Specifications

		CAM-16	CAS-16
Line Inputs	Frequency response	20 Hz – 20 kHz ± 0.5 dB	
	Input level	-14 dBu (155 mV) to +6 dBu (1.55 V)	
	Input impedance	47k ohms	
	Input gain range	20 dB	
	Input level indicator	LED – illuminates above a fixed threshold	
	Input connector	2 x RCA phono jack (stereo)	
Global Input	Frequency response	20 Hz – 20 kHz ± 1 dB	
	High pass filter	-3 dB @ 200 Hz – 18 dB/oct (with in/out switch)	
	Gain range	0 dB to 50 dB	
	Input impedance	5k ohms	
	CMR	>70 dB @ 1 kHz	
	Access port	Channel off/on by closing contact	
Line Output Channel 16	Nominal output level	0 dBu (775 mV)	
	Minimum load	600 ohms	
Headphone Output via RH-8 or WP-8	Nominal output level	100 mW rms per channel with 32 ohm load	
	Optimum load impedance	32 ohms	
	Recommended headphones	Cloud CP32	
Speaker Output via WP-8	Nominal output level	150 mW rms per channel with 8 ohm load	
	Optimum load impedance	>8 ohms	
Other	Power consumption	25 VA with approved external transformer	20 VA with approved external transformer
	Width	482.6 mm (19.0")	
	Height	88.0 mm (3.50") – 2U	
	Depth	170.0 mm (6.70") + connectors	
	Weight	4.0 kg net	3.3 kg
PSU	Output	15 VAC 1.25 A 18.5 VA	
	Weight	0.52 kg net	

Graphs

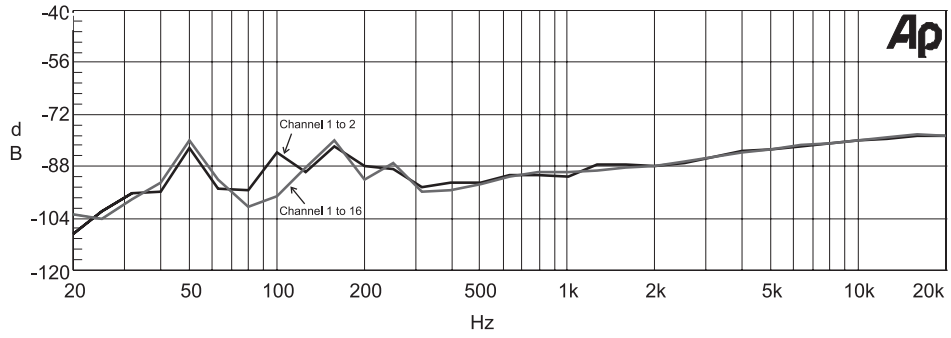

CAM-16 Crosstalk

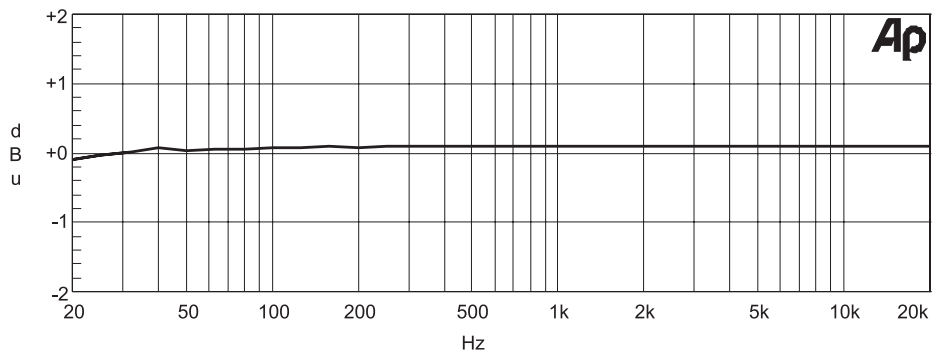

CAM-16 Frequency Response

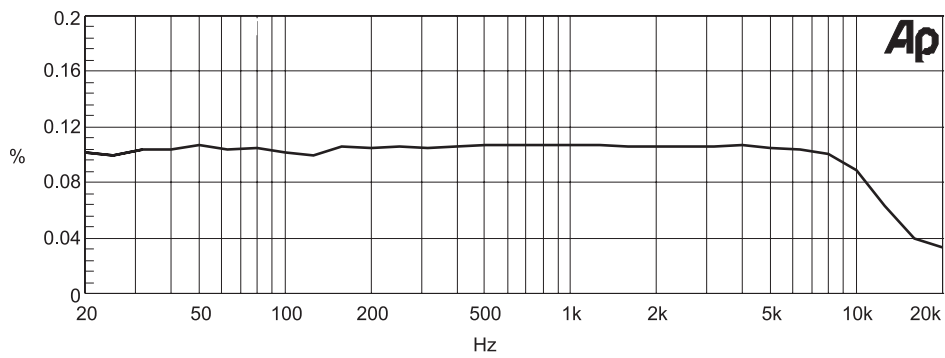

CAM-16 THD and Noise

Architect's and Engineer's Specification

The headphone distribution system shall be a stereo audio matrix having sixteen outputs and eight inputs. Each input shall be provided with a gain control not accessible to the user, and a simple LED system, allowing signals of different levels to be balanced in volume between the eight inputs.

The matrix shall be suitable for mounting in a standard 19" equipment rack, and all controls and connectors apart from the power switch shall be inaccessible to the user. The headphone output connectors shall be of latching, RJ45 type. One output shall also be available in electronically-balanced format as a mono sum of left and right channels.

The matrix shall have an electronically-balanced input capable of being driven with either mic or line level signals; a gain control shall be provided to permit this range of levels. Signals at this global input shall be routed to all headphone outputs when a short-circuit is placed across the pins of a separate access connector. While the global input is active, all other input sources will be muted. The matrix shall also be provided with a means of interfacing it to an external building management, fire control or other emergency system such that a short-circuit placed across two pins of a dedicated connector mutes all sources except the global input.

Headphone connection stations shall be available in wall-mounting formats suitable for housing in standard UK- or US-style electrical boxes. They shall also be available in a self-contained, enclosed housing suitable for fitting onto a variety of surfaces, including tubular metal framework or flat surfaces. Each headphone station shall connect to

the audio distribution matrix with a single CAT-5 cable. A 3.5 mm 3-pole jack socket shall be provided on each headphone station, and it shall be possible to command the matrix to route any one of the eight inputs to the station, and to adjust the headphone's volume from the station itself. The headphone station wired to the output providing the additional mono balanced signal shall control source and level at the balanced output as well as at the local station.

The wall-mounting version of the headphone station shall have additional stereo outputs capable of driving low-power loudspeakers directly. Two sets of outputs shall be provided; one shall operate continuously; the other will mute when headphones are plugged in. These outputs shall also be capable of driving the line inputs of an external audio power amplifier.

It shall be possible to increase the number of headphone stations in use in the system to a maximum of 256 by connecting additional slave units to the audio distribution matrix. Each slave unit shall support a further 16 headphone stations. The slave units shall be suitable for mounting in a standard 19" equipment rack, and shall connect to the matrix by a single multicore cable. All matrix inputs shall be available at any of the outputs of the slave units, and headphone stations connected to the slave units shall operate in an identical manner to those connected directly to the matrix.

The audio distribution matrix shall be the Cloud CAM-16, the slave unit the Cloud CAS-16; the headphone stations shall be the Cloud RH-8 (free-standing) and the Cloud WFP-8 (wall-mounting).