

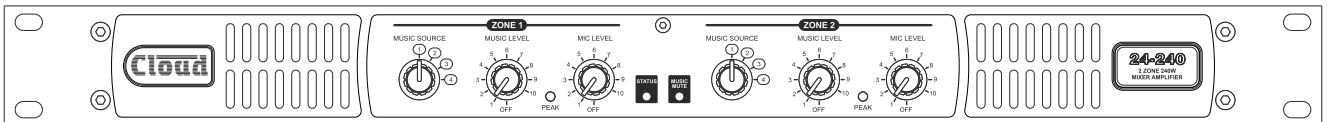

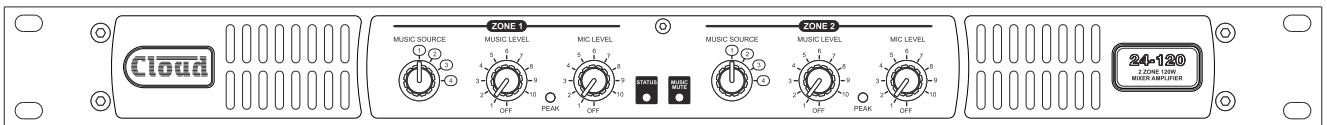

24 SERIES TWO ZONE MIXER-AMPLIFIERS



Installation and User Guide

WARNING:

To reduce the risk of fire or electric shock, do not expose this appliance to rain or moisture.

 <p>CAUTION RISK OF ELECTRIC SHOCK DO NOT OPEN</p>	<p>WARNING: SHOCK HAZARD – DO NOT OPEN AVIS: RISQUE DE CHOC ELECTRIQUE – NE PAS OUVRIR</p>
	<p>The lightning flash with the arrowhead symbol within an equilateral triangle is intended to alert you to the presence of uninsulated dangerous voltages within the product's enclosure that may be of sufficient magnitude to constitute a risk of electric shock.</p>
	<p>The exclamation point within an equilateral triangle is intended to alert the user to the presence of important operating and maintenance (servicing) instructions in the literature accompanying the appliance.</p>

IMPORTANT SAFETY INSTRUCTIONS

1. Read these Instructions.
2. Keep these Instructions.
3. Heed all Warnings.
4. Follow all Instructions.
5. Do not use this apparatus near water.
6. Clean only with a dry cloth.
7. Do not block any ventilation openings. Install in accordance with the manufacturer's instructions.
8. Do not install near any heat sources such as radiators, heat registers, stoves or other apparatus (including amplifiers) that produce heat.
9. Do not defeat the safety purpose of the polarized or grounding - type plug. A polarized plug has two blades with one wider than the other. A grounding type plug has two blades and a third grounding prong. The wide blade or the third prong are provided for your safety. When the provided plug does not fit into your outlet, consult an electrician for replacement of the obsolete outlet..
10. Protect the power cord from being walked on or pinched particularly at plugs, convenience receptacles, and the point where they exit from the apparatus.
11. Only use attachments/accessories specified by the manufacturer.
12.  Use only with the cart, stand, tripod, bracket or table specified by the manufacturer or sold with the apparatus, when a cart is used, use caution when moving the cart/apparatus combination to avoid injury from tip-over.
13. Unplug this apparatus during lightning storms or when unused for long periods of time.
14. Refer all servicing to qualified service personnel. Servicing is required when the apparatus has been damaged in any way, such as power-supply cord or plug is damaged, liquid has been spilled or objects have fallen into the apparatus, the apparatus has been exposed to rain or moisture, does not operate normally, or has been dropped.



Do not expose the apparatus to dripping or splashing, and ensure that no objects filled with water, such as vases, are placed on the apparatus.

L'appareil ne doit être exposé aux écoulements ou aux éclaboussures et aucun objet ne contenant de liquide, tel qu'un vase, ne doit être placé sur l'appareil.



The mains plug is used as the disconnect device and it should remain readily accessible during intended use. In order to isolate the apparatus from the mains, the mains plug should be completely removed from the mains outlet socket.

Le prise du secteur ne doit pas être obstruée ou doit être facilement accessible pendant son utilisation. Pour être complètement déconnecté de l'alimentation d'entrée, la prise doit être débranchée du secteur.



This apparatus is of Class 1 construction and must only be connected to a mains outlet socket with a protective earthing connection.



Terminals marked with the ⚡ symbol may use Class 2 Wiring, but voltages at these terminals may be of sufficient magnitude to constitute a risk of electric shock. The external wiring connected to these terminals requires installation by an instructed person or the use of pre-made leads or cords.

Contents

SAFETY INFORMATION	6
Safety Notes regarding Installation	6
Conformities.....	6
RoHS and WEEE declaration	6
Safety Considerations and Information.....	6
Caution - High Voltage	6
Caution – Mains Fuse	6
Caution – Servicing.....	6
OVERVIEW	7
Introduction.....	7
Applicable Models.....	7
24 Series main features.....	7
What’s in the box.....	8
Schematic Diagram	9
Front panel description	10
Rear panel description.....	11
INSTALLATION	13
Hardware considerations.....	13
Ventilation	13
Power Supply.....	13
Fuses and ratings	13
Connections and Controls	14
Music Inputs	14
Sensitivity & Gain Control.....	14
Music Source Select	14
Music Level Control	14
Remote Control of Music Source and Level	14
Music Equalisation	15
Music Priority	15
Microphone Input	15
Mic Input - connections	15
Gain Control	15
Microphone level controls	15
Microphone Equalisation	15
Paging control and mic priority.....	16
Microphone Access Input.....	16
Outputs	17
Speaker Outputs	17
Connecting to Lo-Z loudspeakers.....	17
Connecting to 70/100 V-line systems.....	17
Power Sharing (Model 24-120 only)	17
Auxiliary Output.....	18
Utility Output.....	18
Facility Port	19
Connecting an active remote module.....	20

Music Mute (Fire Alarm Interface)	21
Auto Power Down	21
Options and Additional Information	21
Multi-zone Applications.....	21
Control of music source and level via external DC	21
Using the Facility Port as an auxiliary input.....	22
24 SERIES SERIAL CONTROL	23
Abridged command set.....	23
Examples	23
APPENDIX	25
PCB jumper locations.....	25
Table of internal jumpers and default settings.....	26
Troubleshooting	27
EMC Considerations	27
Earthing	27
TECHNICAL SPECIFICATIONS	28

SAFETY INFORMATION

Safety Notes regarding Installation

- Do not expose the unit to water or moisture.
- Do not expose the unit to naked flames.
- Do not block or restrict any air vent.
- Do not operate the unit in ambient temperatures above 35°C
- Do not touch any part or terminal carrying the hazardous live symbol ⚡ while power is supplied to the unit.
- Do not perform any internal adjustments unless you are qualified to do so and fully understand the hazards associated with mains-operated equipment.
- The unit has no user-serviceable parts. Refer servicing to qualified service personnel.
- If the moulded plug is cut off the AC power lead for any reason, the discarded plug is a potential hazard and should be disposed of in a responsible manner.

Conformities

This product conforms to the following European EMC Standards:

BS EN 55035:2017 (Immunity)

BS EN 55032:2015 (Emissions)

BS EN 6100-3-2:2-14 (Harmonics)



This product has been tested for use in commercial and light industrial environments. If the unit is used in controlled EMC environments, the urban outdoors, heavy industrial environments or close to railways, transmitters, overhead power lines, etc., the performance of the unit may be degraded.

The product conforms to the following European electrical safety standard:

BS EN 62368-1:2014

RoHS and WEEE declaration

Cloud Electronics Limited manages its business and collaborates with its suppliers to comply with the European Union restriction of the use of certain hazardous substances in electrical and electronic equipment, RoHS Directive (2002/95/EC), that came into force on 1st July 2006, and similar restrictions in other jurisdictions.



The "crossed out wheellie bin" symbol on the product and represented above is there to remind users of the obligation of selective collection of waste. This label is applied to various products to indicate that the product is not to be thrown

away as unsorted municipal waste. At the end of life, dispose of this product by returning it to the point of sale or to your local municipal collection point for recycling of electric and electronic devices.

Customer participation is important to minimize the potential effects on the environment and human health that can result from hazardous substances that may be contained in this product.

Please dispose of this product and its packaging in accordance with local and national disposal regulations, including those governing the recovery and recycling of waste electrical and electronic equipment. Contact your local waste administration, waste collection company or dealer.

Safety Considerations and Information.

The unit must be earthed. Ensure that the mains power supply provides an effective earth connection using a three-wire termination.

Caution - High Voltage

Do not touch any part or terminal carrying the hazardous live symbol ⚡ while power is supplied to the unit. Terminals to which the hazardous live symbol refers require installation by a qualified person.

Caution – Mains Fuse

Cloud 24 Series mixer-amplifiers contain no user-replaceable fuses. Mains over-current protection is provided by the fuse in the IEC receptacle: only replace this fuse with one of an identical type and rating.

If the replacement fuse blows immediately it indicates that the mixer amplifier has developed a fault, which should be referred to competent service personnel.

Caution – Servicing

The unit contains no user serviceable parts. Refer servicing to qualified service personnel. Do not perform servicing unless you are qualified to do so. Disconnect the power cable from the unit before removing the top panel and do not make any internal adjustments with the unit switched on. Only reassemble the unit using bolts/screws identical to the original parts.

OVERVIEW

Introduction

The Cloud 24 Series are two-zone audio mixer-amplifiers, with applications in Licensed, Retail, Leisure and similar venues.

Two models are available to suit different output power requirements (2 x 120 or 2 x 240 watts). Otherwise the models have almost identical facilities.

The mixer-amplifiers have inputs for four stereo line signals and a microphone signal. Front panel controls are provided for music source selection, music level and microphone level in each of the two zones. A multi-function Facility Port allows the connection of remote active input modules.

An extensive selection of pre-set controls is located on the rear panel; primary unit configuration options are selectable using rear panel DIP switches. Certain installation options are set using internal PCB jumpers.

The units are compatible with standard Cloud remote control plates from the RL and RSL Series, and may also be remotely control using RS-232 serial commands.

Applicable Models

This Installation and User Guide describes the installation and operation of the following models:

- Cloud 24-120: 2 x 120 W mono mixer-amplifier for 4 or 8 ohm loudspeakers, or 70/100 V-line loudspeaker systems
- Cloud 24-240: 2 x 240 W mono mixer-amplifier for 4 or 8 ohm loudspeakers, or 70/100 V-line loudspeaker systems

All references to "24 Series" throughout this Installation and User Guide may be taken as being applicable to either model.

24 Series main features

- Provides amplification for two zones, with simple per-zone control of music, mic sources and paging in a single unit
- Available in two versions, with output power ratings of 120 or 240 W per zone
- Transformerless output stages: can be configured to drive either 70/100 V-line systems directly, or low impedance loudspeakers (4/8 ohms)
- Model 24-120 permits power sharing in Hi-Z mode: maximum available power of 240 W may be shared as required between the two channels
- Front panel controls for music source, music level and mic level in each zone
- Two unbalanced and two balanced stereo line inputs, with individual gain trim controls

- Balanced mic input; 12 V phantom power available
- Fixed 100 Hz hi-pass mic channel filter
- Separate microphone limiter circuit to prevent power stage limiter from ducking music signal in the presence of high mic levels
- Separate HF/LF EQ adjustments (rear panel) for mic signals and music source
- Paging control of Mic input via short-to-ground access connection for each zone
- Selectable VOX mic-over-music priority
- Selectable LINE 4 priority
- Selectable pre-announcement chime
- Music Mute control input (N/O and N/C) for interface to an emergency system
- Facility port for connection of LM-2, L-1 or M-1 remote input modules via screened Cat 5 cable; LM-2 also allows remote control of music level and line input selection
- Facility Port supports BT-1 Bluetooth input module
- Compatible with standard Cloud remote control plates: RL-1 Series (music level) and RSL-4/RSL-6 Series (music level and source selection)
- RS-232 serial control port; protocol includes global and per-zone functions
- Power amplifier protection circuitry
- Power amplifier input limiters
- Switchable 65 Hz high-pass filter (per-zone): reduces transformer saturation in 70/100 V-line systems
- Balanced Utility output with separate rear panel controls for music/mic mix: music source can follow Zone 1 selection or be permanently LINE 1
- Per-zone auxiliary output from pre-amp (balanced, line level)
- Automatic power-down function (user-selectable)
- Thermostatically-controlled forced-air cooling
- 1U 19" rack mounting unit

Available Options:

- LM-2 remote active mic/line input module with music source selection and volume controls
- BT-1 remote Bluetooth wireless audio input module
- L-1 remote active line input module
- M-1 remote active mic input module
- RL Series remote control plates for music volume
- RSL Series remote control plates for music source selection and level
- PM Series paging mics

What's in the box

Please check the shipping carton for damage before opening. If there is damage, please contact your Cloud agent and the shippers.

The packing carton should contain the following items:

- 24 Series mixer amplifier
- IEC mains lead (AC cord) with moulded plug appropriate to the territory
- Set of mating plug-in screw-terminal connectors
- Set of four plastic feet, with fixings
- This manual

Schematic Diagram

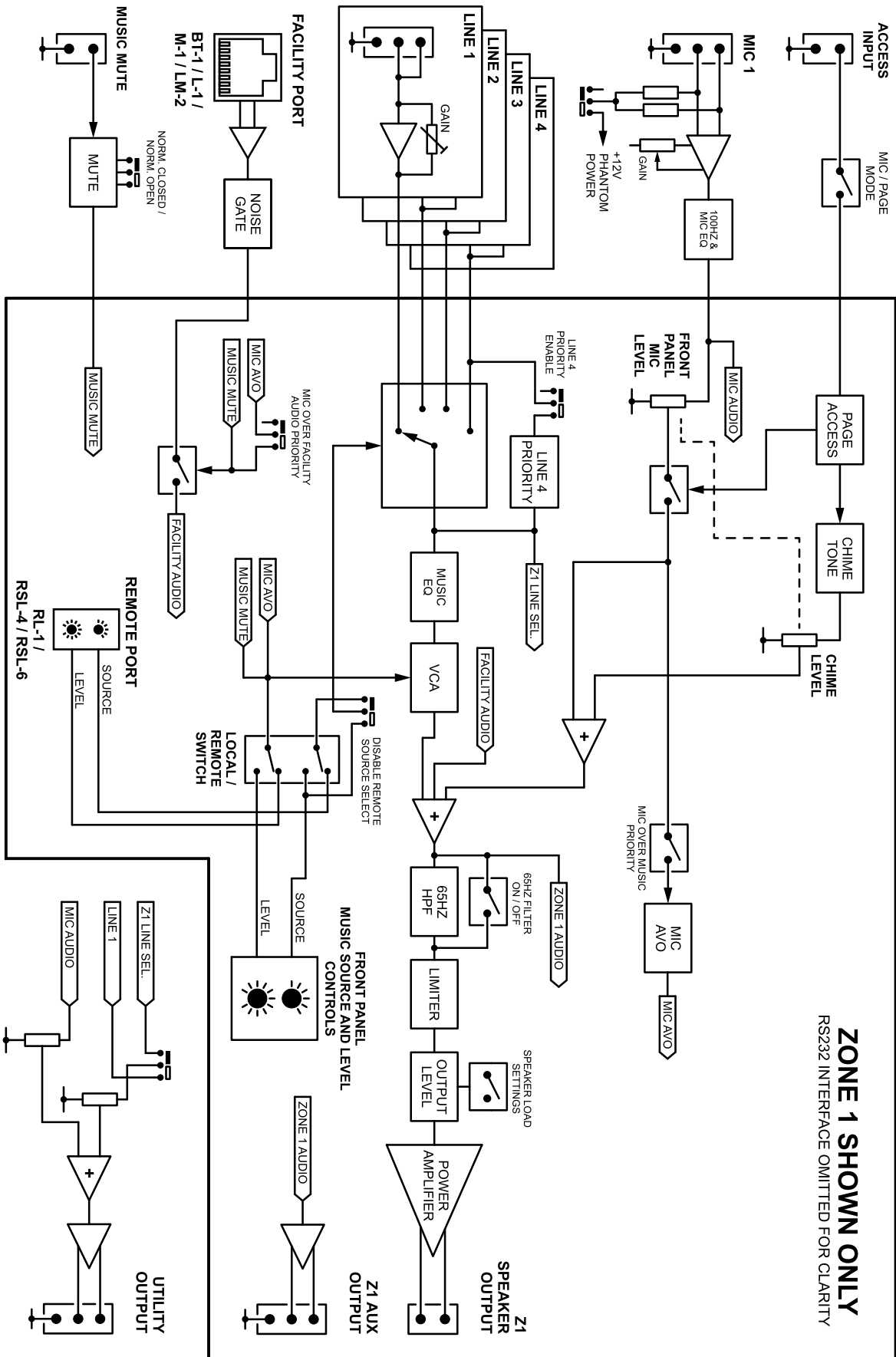

Front panel description

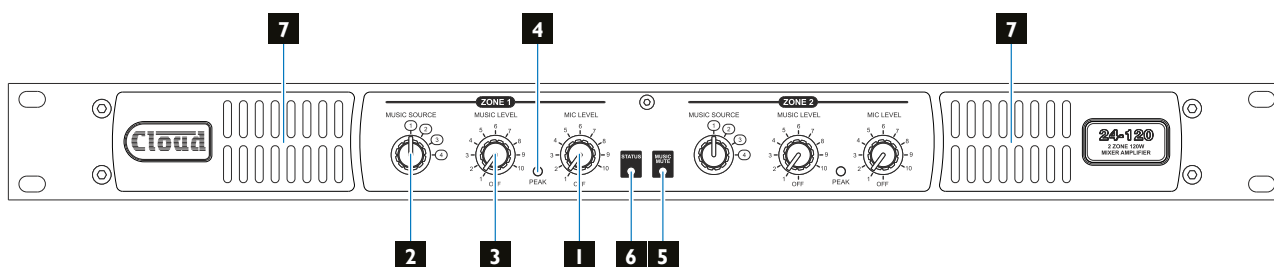

24-120 front panel: 24-240 is functionally identical.

1. **MIC LEVEL** – per-zone level controls for the Mic Input.
2. **MUSIC SOURCE** – per-zone selection of active Line Input (1 to 4).
3. **MUSIC LEVEL** – adjusts level of selected Line Input in each zone.
4. **PEAK** – per-zone red LED: illuminates if either Mic or Line signal levels are high enough to activate the zone’s output limiter.
5. **MUSIC MUTE** – red LED: illuminates when external Music Mute is active.
6. **STATUS** – bicolour LED indicates as follows:

INDICATION	MEANING
Off	Power off
Green	Normal operating mode
Red	Standby (APD) mode
Flashing green	Power reduction due to high temperature
Flashing red	Fault condition - outputs muted

7. **Forced air cooling intake slots** – do not block.

Rear panel description

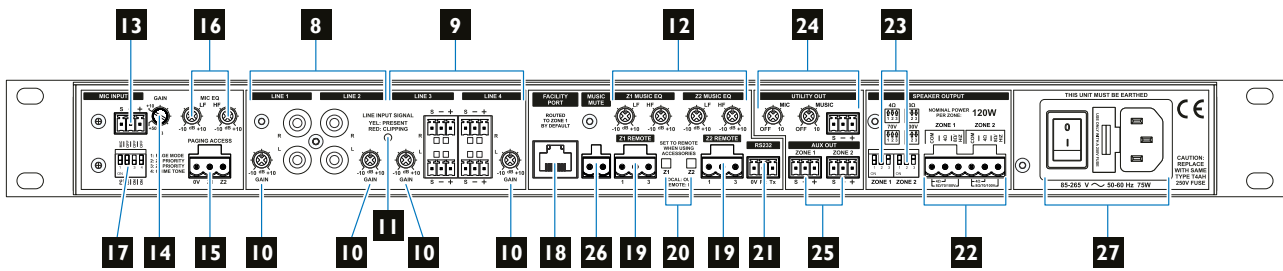

24-120 rear panel: 24-240 is functionally identical.

8. **LINE 1** and **LINE 2** – unbalanced stereo line inputs for music sources.
9. **LINE 3** and **LINE 4** – balanced stereo line inputs for music sources.
10. **GAIN 1** to **GAIN 4** – level trims for each line input.
11. **LINE INPUT SIGNAL** – bicolour LED; illuminates yellow when an input signal is detected at any of the line inputs, and red if any input signal exceeds clip level.
12. **Z1** and **Z2 MUSIC EQ** – LF and HF EQ adjustment of music channel for each zone.
13. **MIC INPUT** – balanced input for microphone.
14. **GAIN** – level trim for mic input.
15. **PAGING ACCESS** – external paging control port.
16. **MIC EQ** – LF and HF EQ adjustment for microphone.
17. 4-pole DIP switch for configuring paging operation:

SWITCH	NAME	FUNCTION
SW1	PAGE MODE	MIC 1 mode – configures the mic input for paging use
SW2	Z1 PRIORITY	Enables mic-over-music priority in Zone 1
SW3	Z2 PRIORITY	Enables mic-over-music priority in Zone 2
SW4	CHIME TONE	Enables pre-announcement chime tone in both zones

18. **FACILITY PORT** – RJ45 socket for connection of remote active input/control modules such as the LM-2, BT-1, L-1 and M-1. This port may alternatively be used as an additional balanced line input. Signals applied here are routed to Zone 1 by default, but may be routed to both zones by moving an internal jumper.
19. **Z1** and **Z2 REMOTE** – for connection of RL-1 or RSL-4/RSL-6 remote control plates.
20. **Z1** and **Z2 Local/Remote** switches – press to enable the corresponding **REMOTE** port and the remote control functions of the Facility Port: disables front panel music controls.
21. **RS232** – bi-directional RS-232 interface: accepts commands to select or adjust various unit functions and parameters from an external AV control system.
22. **SPEAKER OUTPUTS** for each zone – connect to either low-Z loudspeakers (4 or 8 ohms) or to 70/100 V-line distribution system.

23. Speaker settings – two 3-pole DIP switches for setting output configuration independently in each zone:

SWITCH	ZONE	FUNCTION
SW1	ZONE 1	Enables Z1 65 Hz high-pass filter (use with 70/100 V-line operation)
SW2		Configures Z1 output for low-Z (ON) or high-Z (70/100 V-line) operation (OFF)
SW3		When SW2 is set ON, selects Z1 output impedance to suit 4 ohm or 8 ohm loudspeakers When SW2 is set OFF, selects 70 V-line or 100 V-line operation for Z1
SW4	ZONE 2	Enables Z2 65 Hz high-pass filter (use with 70/100 V-line operation)
SW5		Configures Z2 output for low-Z (ON) or high-Z (70/100 V-line) operation (OFF)
SW6		When SW5 is set ON, selects Z2 output impedance to suit 4 ohm or 8 ohm loudspeakers When SW5 is set OFF, selects 70 V-line or 100 V-line operation for Z2

24. **UTILITY OUTPUT** – a balanced output with an independent mic/music mix: the music source can be set by internal jumpers. Suitable for use with loop amplifiers. The output has two associated preset level controls, **MIC** and **MUSIC**.
25. **AUXILIARY OUTPUT** – per-zone balanced line level outputs for feeding additional amplifiers, etc.
26. **MUSIC MUTE** – Emergency control input for muting music.
27. IEC mains input with mains switch and integral fuseholder.

INSTALLATION

Hardware considerations

The 24 Series mixer-amplifier is built in a 1U-high 19" rack mount enclosure. It is recommended that it is installed in a 19" rack wherever possible. Model 24-120 is 150 mm deep, and Model 24-240 is 230 mm deep; it is recommended that at least 100 mm of additional rack depth should be available to allow for rear connectors and cabling.

The choice of installation location will be dictated by the specifics of the system and building layout. It is recommended that wherever possible, the mixer-amplifier should be mounted adjacent to as many of the music sources (CD players, music servers, TV receiver boxes, etc.) as practical.

When deciding the mixer-amplifier's location, bear in mind that access to it (particularly the rear panel) will probably be required even if a full complement of remote controls is being fitted as part of the system, as certain adjustments can only be made on the unit itself.

Ventilation

24 Series mixer-amplifiers use both convection and forced-air cooling; at 45°C the internal fan is activated at low speed, it switches to high speed if the temperature exceeds 60°C.

In both models, air is taken in through two sets of ventilation slots in the front panels and exhausted through a single set in the right-hand side panel (as viewed from the front): ensure that all these are kept unobstructed by cabling or any other items. It is recommended that a 1U blank panel is fitted above the mixer-amplifier to aid heat dissipation; slotted panels are not recommended as they defeat the action of forced-air cooling.

24 Series mixer amplifiers have been designed to operate in an ambient temperature range of 0°C to 35°C. While satisfactory operation outside of this recommended temperature range may be achievable in a particular installation, no guarantee can be given regarding full adherence to the performance specifications (see the Appendix section of this manual). Installers should always endeavour to fit the mixer-amplifier in a location where the recommended temperature range is not exceeded. To help achieve this, we recommend that the unit is not rack-mounted immediately above other equipment which generates heat (e.g., older designs of power amplifier).

If the unit is to be used free-standing (i.e., not mounted in a rack), the push-rivet plastic feet supplied in the accessory pack should be fitted to the bottom of the enclosure.

Power Supply

24 Series mixer-amplifiers have an internal power supply of the "universal" type, and will operate on all AC mains supplies of between 85 V and 265 V, 45 to 65 Hz. An IEC mains cable with a plug appropriate for each country is supplied with the unit. The units are very energy-efficient and consume less than 6 W in Idle mode; see the Technical Specifications on page 28 for more details.

Fuses and ratings

The only externally-accessible fuse is the AC mains fuse integral with the IEC receptacle on the rear panel. **Only replace a fuse with one of exactly the same type.** The IEC receptacle has space for a spare fuse; one is supplied with the unit.

The table below gives the correct fuse type:

Model	Fuse Type	Fuse size	Rating
24-120	T4AH 250V	20 mm x 5 mm	4 A
24-240	T5AH 250V	20 mm x 5 mm	5 A

If a replacement fuse blows immediately, it indicates that the mixer-amplifier has developed a fault, which should be referred to competent service personnel.

Internally, a 20 mm x 5 mm 2.5 A time-delay fuse protects each power supply module (one in Model 24-120, two in Model 24-240). This is a service component, and should not require attention. Failure of this fuse indicates a fault condition, which should be immediately referred to a competent technician or authorised service centre.

Connections and Controls

Music Inputs

The unit has four stereo line inputs; these inputs are suitable for most music sources such as compact disc players, music servers, laptops, satellite receivers and the like. Each stereo input is summed internally to mono.

Two inputs – **LINE 1** and **LINE 2** - are unbalanced, and use standard phono sockets (RCA jacks) in pairs. **LINE 3** and **LINE 4** are balanced, and use pairs of 3-pin 3.5 mm-pitch screw terminal connectors. The input impedance for all line inputs is greater than 10 kohms. Connection to the balanced inputs should be as shown below:

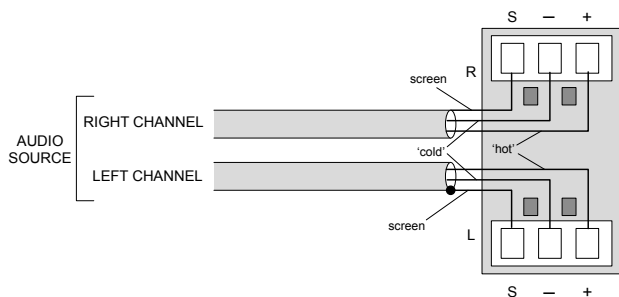

LINE 4 input can be configured to have automatic priority over the other music sources: see Music Priority, page 15

Sensitivity & Gain Control

All four stereo line inputs have a preset **GAIN** control on the rear panel adjacent to the respective input sockets. The control has a range of 20 dB allowing the input sensitivity to be varied from -12 dBu (195 mV) to +8 dBu (2.0 V).

The **GAIN** control should be adjusted so that all the input sources are operating at approximately the same volume, and that the front panel **MUSIC LEVEL** controls have a useful range of control.

The rear panel is fitted with a bicolour **LINE INPUT SIGNAL** LED ([11] at page 11), which is a useful aid to system set-up. It confirms both that a music source signal is present at the unit inputs and that all available sources are of a correct level. The LED illuminates yellow if a signal is present at any of the line inputs: note that the signal detection is post the rear panel **GAIN** controls, but pre the music EQ and level controls. The LED's threshold level is -30 dBu with the rear panel **GAIN** control set to 0 dB. **GAIN** should be set so that the LED never turns red under any circumstances, as this will indicate an overload level at the power stage inputs, and very harsh clipping will result.

Music Source Select

Each of the two zones has a front panel **MUSIC SOURCE** rotary switch, used to select the desired music signal for the zone. Remote control of source selection is possible with a remote control plate (RSL-4/RSL-6), or active input/remote control module (LM-2), see below and page 19 respectively.

Music Level Control

Two front panel mounted **MUSIC LEVEL** controls are provided, one for each zone.

Remote control of music level is possible with a remote control plate (RSL-4/RSL-6 or RL-1), or active input/remote control module (LM-2), see below and page 19 respectively.

Remote Control of Music Source and Level

24 Series mixer-amplifiers are compatible with standard Cloud remote control plates: RSL-4/RSL-6 Series (music source select and level) and RL-1 Series (level only). Remote control is available independently in either or both zones.

NOTE: RSL Series plates are available in 4-way (RSL-4) and 6-way (RSL-6) versions. The RSL-4 allows selection of four music sources and is thus ideal for use with 24 Series mixer-amplifiers. The RSL-6 remote control plate allows selection of six music sources, as some other Cloud products have six music inputs. The RSL-6 may be used with the 24 Series provided that internal PCB jumpers J6 and/or J8 are moved from their default (RSL-4) position to the alternative (RSL-6) position: in this case, the music channel will be muted in two of the source switch settings. See page 25 for details of jumper locations.

All types of plate may be connected at the two rear 3-pin, 5 mm-pitch screw terminal connectors (**Z1 REMOTE** and **Z2 REMOTE**), using the wiring shown below:

REMOTE LEVEL CONTROL WIRING

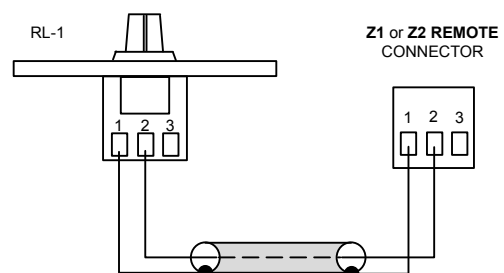

SINGLE-CORE SCREENED CABLE MAY BE USED

REMOTE SOURCE & LEVEL CONTROL WIRING

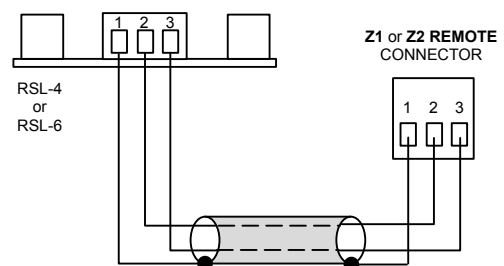

USE TWO-CORE SCREENED CABLE

Use two-core (RSL-4/RSL-6 or RL-1) or single-core (RL-1 only) screened cable to connect the remote level plate (max length 100 metres).

Setting the blue Z1 or Z2 LOCAL/REMOTE button adjacent to the REMOTE connectors to REMOTE (button IN) activates the remote control plate and disables both the front panel level and source select controls for that zone. If an RL-1 is being used, the internal jumper J5 (Zone 1) or J7 (Zone 2) should be moved from its default 'SW' setting to 'FR', to override the disabling of the front panel source select switch. See page 25 for location of jumpers.

Music Equalisation

MUSIC EQ controls are provided for the music signals in each zone. These preset controls are located on the rear panel above the Z1/Z2 REMOTE connectors (see [12] at page 11). The LF controls have a range of ± 10 dB at 50Hz and the HF controls have a range of ± 10 dB at 10 kHz.

Note that these controls do not affect a signal applied to the unit via the Facility Port: see page 19.

Music Priority

A jukebox, digital sound store or other audio source can be given automatic priority over all other music inputs in either or both zones by connecting it to Line Input 4 and moving internal jumpers J11 (Zone 1) and/or J12 (Zone 2) from DIS (factory default position) to EN. When this priority is enabled, the unit will operate normally until a signal is detected at Line Input 4, when the selected source for a zone (typically background music) is muted, allowing the source connected to Line 4 to replace it. Once the signal at Line Input 4 stops, the selected source will smoothly restore to its former level over a period of 6 seconds. See page 25 for location of jumpers.

Note that Line 4 priority does not apply to the Facility Port. Remote active modules connected to the Facility Port will normally have priority (but in the case of the LM-2, see the Installation Guide for further information).

Microphone Input

A microphone input is provided; the microphone pre-amplifier is an electronically balanced, transformerless design configured for optimum low noise performance. The input impedance is 3.3 kohm and is suitable for microphones in the 200 ohm to 600 ohm range.

Input is via the 3-pin, 3.5 mm-pitch screw terminal MIC INPUT connector on the rear panel ([13] at page 11).

Mic Input - connections

Mic Input can be configured for paging or announcements independently in each zone. By default, the mic input is independent and is simply mixed with the selected line input: when reconfigured for paging, it operates as a standard Cloud-

type paging input, with selectable mic-over-music priority and triggering by either contact closure or automatic signal detection. It is then compatible with paging microphones using zone selection by contact-closure such as the Cloud PM Series, including the PM1 single-zone microphone. See page 16 for more details.

Connect microphones as shown below

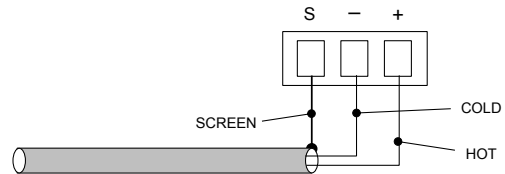

12 V phantom power is available at the mic input, and is activated by setting internal jumper J9 to the ON position. See page 25 for locations of internal jumpers. Care should be taken to ensure that phantom power is activated only when the microphone connected to the input requires it – i.e., a capacitor or electret type; other types of microphones (such as dynamic) may be damaged if a DC voltage is applied to them.

Gain Control

The mic input has a preset GAIN control adjacent to the input connector ([14] at page 11). The GAIN control has a range of 40 dB, from 10 dB to 50 dB.

Microphone level controls

Two front panel MIC LEVEL controls are provided: these provide the user with a means of adjusting mic volume independently in each zone. The rear panel GAIN control should be set at a level where distortion does not occur even when a front panel LEVEL control is fully clockwise. If the mic level is set too high in either zone, the corresponding front-panel PEAK LED [4] will illuminate. Note that these LEDs also indicate excessive music level.

Microphone Equalisation

The microphone input is routed to the mixer stage via a fixed high pass filter and an adjustable EQ section. The fixed filter attenuates the signal below 100 Hz, which helps to reduce the effects of microphone handling noise.

The two preset MIC EQ controls are on the rear panel ([16] at page 4) adjacent to the mic input; the LF and HF controls provide ± 10 dB of adjustment below 100 Hz and above 5 kHz respectively. After installation, some test announcements should be made, ideally by the people who will normally make them. The Mic EQ should be adjusted if necessary to maximise voice clarity.

Paging control and mic priority

The mic input can be reconfigured to operate as a paging input with the 4-way DIP switch [17] below the mic connector. For normal (non-paging) operation, all four switches should be in the 'up' position.

- **SW1 – MIC/PAGE:** in the MIC position (switch up), the mic input operates as a standard microphone input. In the PG position (switch down), it operates as a typical Cloud paging input. In Page Mode, the **PAGING ACCESS** contacts will need to be shorted in order for the Mic input to become active.
- **SW2 – Z1 PRIORITY:** set to ON (switch down) to enable Mic-over-Music priority in Zone 1. This can be selected in both Mic Mode and Page Mode, i.e., regardless of the setting of SW1. In MIC mode the priority trigger is always VOX. i.e., the presence of a signal at the mic input will automatically trigger the priority function. In PAGE mode, priority is triggered by closure of the **PAGING ACCESS** contacts for Zone 1. When active, the Mic-over-Music priority function will attenuate the level of signals at both LINE and FACILITY inputs by 25 dB. When triggering is released, the music will fade up over approximately 3 seconds.
- **SW3 – Z2 PRIORITY:** this switch performs the same as function as described for SW2 in Zone 2.
- **SW4 – CHIME:** 24 Series mixer-amplifiers have an internal pre-announcement chime generator. With SW4 set to ON (switch down), the chime is triggered by the **ACCESS** input when the mic input is in Page Mode (SW1 set to PG), thus the chime is heard only in the zone selected for paging. The default setting is OFF. An internal preset-type **CHIME GAIN** control is provided to trim the chime level by +/-10 dB. The chime volume in each zone is set by the front panel **MIC LEVEL** controls: installers are recommended to initially adjust these (in conjunction with the rear panel Mic **GAIN** control) to suit the paging microphone, and then adjust the internal **CHIME GAIN** control as required. See page 25 for the location of the internal control.

Microphone Access Input

The paging access control input is on the 3-pin, 5 mm-pitch screw-terminal **PAGING ACCESS** connector [15]. The **PAGING ACCESS** input provides compatibility with "contact-closure" paging microphones, and allows announcements to be made in either or both zones. In Page Mode (SW1 down), the mic input is muted as long as the Z1 or Z2 pin of the access connector is not connected. When the Z1 and/or Z2 pins are connected to the 0V pin, the mic input becomes active. The internal chime generator will also be activated if SW4 is set to ON.

In both Mic and Page Modes, the music signal is faded back up after the announcement is complete over a period of approx. 3 seconds.

Outputs

Speaker Outputs

The power amplifier stages are fully protected against DC offset and output over-current, and also has two-stage thermal protection. Activation of the protection circuitry mutes the power amplifier stage until the fault condition clears. All protection conditions will automatically self-clear once the fault condition is removed, or if the amplifier is power-cycled. The exception to this is muting due to detection of DC at the output terminals, which will require manual power-cycling to clear. A switch-on delay function mutes the output during power-up and power-down to protect loudspeakers.

Each zone of a 24 Series mixer-amplifier has both a low impedance output (4 or 8 ohms) and a high voltage output for 70/100 V-line speaker systems. Both output types are available on the two 3-pin 5 mm-pitch screw-terminal **SPEAKER OUTPUT** connectors [22]. The two zones may be configured independently, but in each zone, only one of the two output options can be used at a time.

The output type is selected with **SPEAKER SETTINGS** DIP switch [23]: see details below

Connecting to Lo-Z loudspeakers

For low-impedance operation, set SW2 to LO-Z (switch down). The mixer-amplifier can deliver its rated power into a 4 ohm or 8 ohm load: set SW3 up (4 ohms) or down (8 ohms) as appropriate. Installers fitting multiple low-impedance loudspeakers (generally 8 ohms) should employ series and parallel wiring to produce, where possible, a total load impedance of either 4 or 8 ohms.



IMPORTANT: Under no circumstances should the total load impedance be less than the output impedance selected with SW3 (i.e., 4 or 8 ohms).

For low-impedance operation, wire the **SPEAKER OUTPUT** connector according to (a) or (b) in the diagram below.

Connecting to 70/100 V-line systems

Series 24 mixer-amplifiers' output stages use a transformerless design which can directly drive 70 V-line or 100 V-line loudspeaker systems. The power amplifier stage is rated at 120 W per-zone (Model 24-120) or 240 W per zone (Model 24-240).

Connect to a 70 V-line or 100 V-line speaker system by setting SW2 to high-Z (switch up) and setting SW3 either up for 70 V-line operation, or down for 100 V-line operation, as required: see (c) in the diagram below. Note that units will be factory-set to 100 V "out of the box".

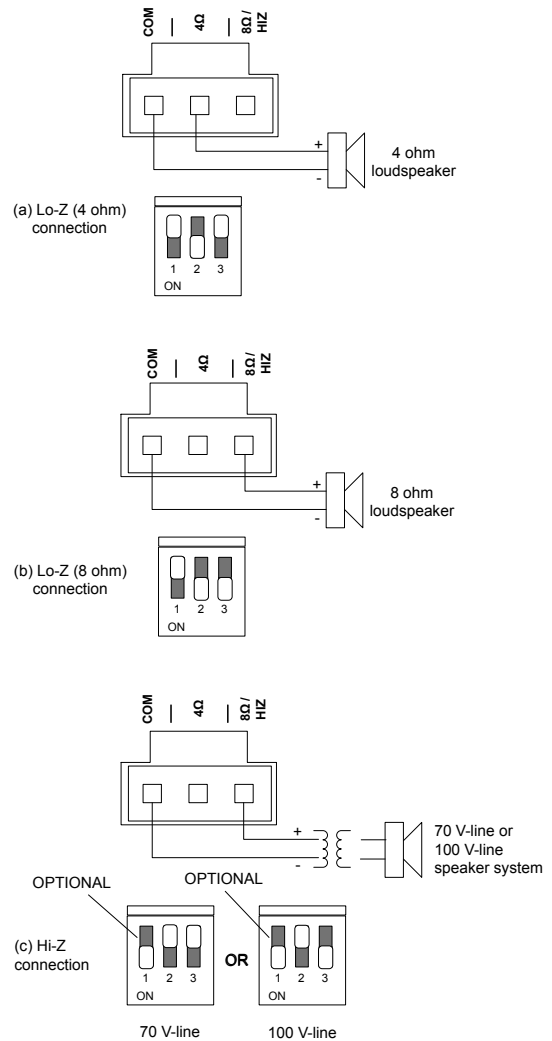

When driving 70/100 V-line loudspeaker systems there is a risk of transformer core saturation at high levels and low frequencies, which can produce distortion. To prevent this, the mixer-amplifier's output stages is provided with a 65 Hz high-pass filter, which may be enabled by setting **SPEAKER SETTINGS** switch SW1 to on (switch down).

Power Sharing (Model 24-120 only)

Model 24-120 incorporates the principle of Power Sharing when both outputs are configured for Hi-Z mode (i.e., for 70/100 V-line operation). Its maximum power output capability is 240 W. Each amplifier channel (zone output) is capable of delivering 240 W, but this figure can only be realised if *the other zone output is unused*.

Power Sharing is configured by adjusting the power tapping (wattage setting) on all 70 V-line or 100 V-line speakers. In each zone, the tappings should be set to give the required total wattage (eg. Zone 1: 40 W total, Zone 2: 200 W total). The power sharing between zones can be any ratio so long as the total wattage for both zones does not exceed 240 W.

The great advantage of power sharing is that it allows installers to use one zone output to drive speakers where only low power is needed, and the other for areas where more is needed.

Auxiliary Output

24 Series mixer-amplifiers are provided with auxiliary outputs from each zone: these are available on the **AUX OUTPUT** connectors [25]. These may be used to drive additional amplifiers, for recording, or any other purpose where system "expansion" is required. The connector is a 3-pin, 3.5 mm-pitch screw terminal type.

The signal at the Auxiliary Output is impedance balanced and line level, and can thus be used to drive most external equipment directly. The wiring is as follows:

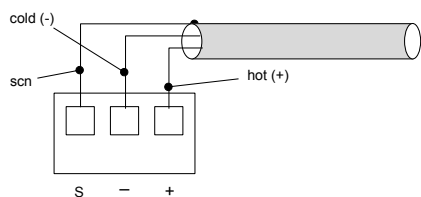

AUX OUTPUT: BALANCED CONNECTION

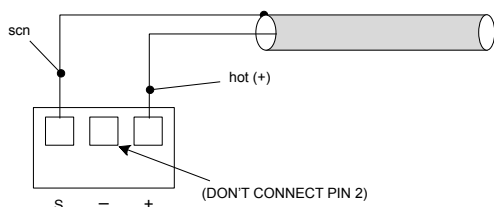

AUX OUTPUT: UNBALANCED CONNECTION

The signal at the **AUX OUTPUT** connector is the mix of music and mic channels set up for the zone by the front panel level controls.

Note that the music signal at the Auxiliary Output is not subject to the action of the 65 Hz high-pass filter. However, the Mic EQ and Music EQ controls are effective on the Auxiliary Output mix (for the mic and music components of the mix respectively).

Utility Output

The mixer-amplifier also has a Utility output, which is ideal for providing the feed to a loop amplifier, or for connection to low-power amplifiers driving speakers in secondary areas such as corridors or toilets. It is an impedance-balanced, line level signal available at the **UTILITY OUT** connector [24], which is a 3-pin, 3.5 mm-pitch screw-terminal type.

The Utility output can have an independent mix of music and mic signals: the mix is adjusted with the rear panel **MIC** and **MUSIC** preset controls adjacent to the **UTILITY OUT** connector. By default, the music source will be that selected for Zone 1 – either by the front panel Zone 1 **MUSIC SOURCE** control, or a remote control plate in Zone 1. Alternatively, the Utility output music source may be set to be permanently that connected to Line Input 1: this is done by moving internal jumper J1 from Z1 to L1. If J1 is set to Z1, the Utility Output will be affected by Line 4 Priority, but not Mic-over-Music Priority. If J1 is set to L1, it will not be affected by any Priority actions. See page 25 for details of PCB jumper locations.

Note also that the level of the mic signal in the Utility output mix is not affected by either front panel **MIC LEVEL** control.

Facility Port

24 Series mixer-amplifiers are provided with a **FACILITY PORT** in the form of a rear panel RJ45 connector [18]. The primary use of the Facility Port is for the connection of remote active modules such as the LM-2 or BT-1, but it may also be used as a general-purpose auxiliary balanced input (see page 22 for more information on this application). The Facility Port audio path includes a noise gate to help minimise unwanted background noise from the external source.

If Mic-over-Music priority is enabled (see "Paging control and mic priority" on page 16), an input at the Facility Port will be reduced in level by 25 dB in the same way as the other Line Inputs, though this may be overridden by moving internal jumper J4 from its default setting (DIS) to EN. See page 25 for locations of PCB jumpers.

An audio source connected to an active module will be routed via the Facility Port to Zone 1 by default, and the music source currently selected for Zone 1 will be muted and replaced by the Facility Port audio. The Facility Port routing may be altered by moving internal PCB jumper J3 from Z1 to ALL: in this setting, audio sources connected to remote active modules will be routed to both zones.

The remote control functions of an LM-2 (music source and level) will affect only the music signal routed to Zone 1. However, note that if J3 is set to ALL, the remote control functions of an LM-2 module will be disabled (see also below).



IMPORTANT: In order for the remote control functions on an LM-2 module to operate (with J3 in the default Z1 setting), the rear panel Z1 LOCAL/REMOTE button must be set to REMOTE (button IN). This will disable the front panel **MUSIC SOURCE** and **MUSIC LEVEL** controls, and control of music level and/or source selection will be available from the remote module. The Z1 LOCAL/REMOTE button should be left set to LOCAL (button OUT) when a BT-1, L-1 or M-1 module is connected to the Facility Port.



IMPORTANT: do not connect BOTH an LM-2 module (or an RSL plate connected via a BT-1 module) to the Facility Port AND an RL or RSL Series plate to the Zone 1 **REMOTE** connector, as the remote controls will conflict.



IMPORTANT: if jumper J3 is set to ALL, remote music source and level control via the Facility Port is disabled: in this case, set the Z1 LOCAL/REMOTE button to REMOTE only if the Z1 REMOTE port is in use, and to LOCAL otherwise.

The pinout of the Facility Port connector is given in the table below:

PIN	USE	Cat 5 CORE*
1	Audio 'cold' phase (-)	White + Orange
2	Audio 'hot' phase (+)	Orange
3	Priority VCA control	White + Green
4	+ 12 V	Blue
5	0 V	White + Blue
6	-12 V	Green
7	Music level control (0 to 10 V)	White + Brown
8	Music source select control (0 to 10 V)	Brown
SCN	GND ref for system music controls	Connector shell

* Standard wiring for pre-made cables

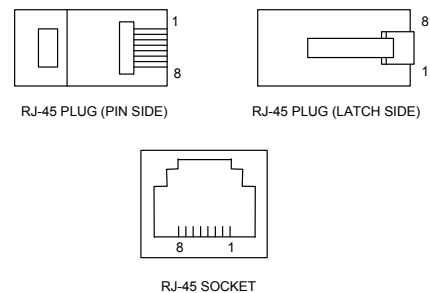

The various optional Cloud remote active modules operate from DC power supplied by the 24 Series mixer-amplifier. The current consumed by each module is minimal and in the vast majority of installations there will be no power supply issues.

Connecting an active remote module

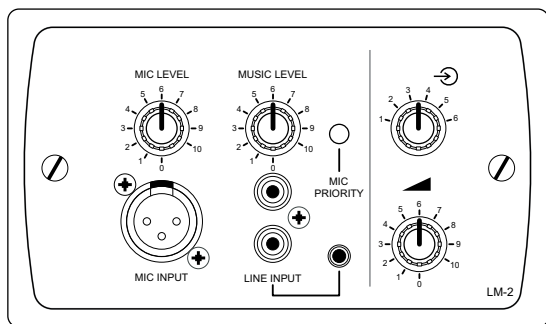

LM-2 mic/line input module, with music source and level controls

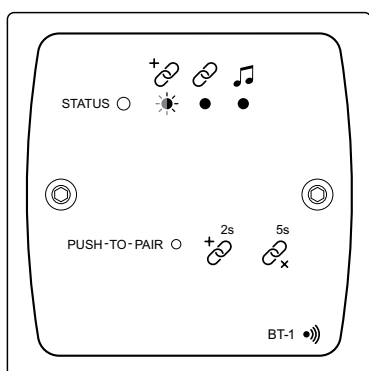

BT-1 Bluetooth wireless audio input module

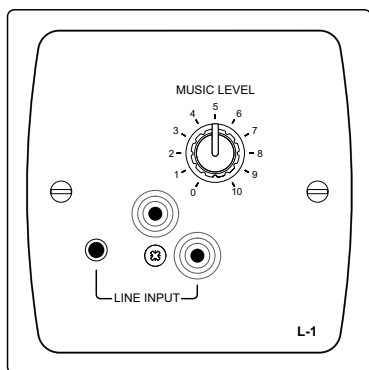

L-1 line input module

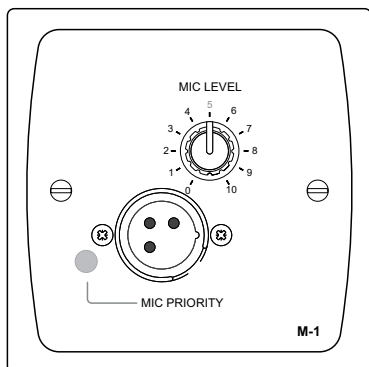

M-1 mic input module

LM-2: The LM-2 is an active input module which allows a microphone and a stereo line input in a remote location to be connected to the 24 Series mixer-amplifier. The module also includes the functions of a Cloud RSL-6 Remote Control Plate, which allows remote control of music level and music source selection in Zone 1 (see notes above re Facility Port routing).

BT-1: The BT-1 is a Bluetooth remote audio input module which enables compatible portable devices such as laptops, tablets and smartphones to stream audio wirelessly to the module, and thus into the audio system supplying either Z1 only, or both zones, according to the setting of J3. It is also possible to connect an RL or RSL Series remote control plate to a BT-1, to allow control of music source and level via the Facility Port.

NOTE: 24 Series units are only compatible with the BT-1F variant of the BT-1: do not attempt to connect variant BT-1E.

L-1/M-1: The L-1 and M-1 are remote active input modules which allows a microphone (M-1) or stereo line level source (L-1) to be connected within a zone and then routed to the zone's audio system. The M-1 includes a mic level control and a switchable mic-over-music priority function; the L-1 is fitted with both phono sockets (RCA jacks) and a 3.5 mm 3-pole jack socket, together with a music level control.

Active remote modules should be connected to the 24 Series' **FACILITY PORT** using screened Cat 5 or Cat 6 cable. (Note that as the cable carries analogue audio, only screened Cat 5/6 should be used.) The LM-2 includes controls for local music level and source selection, the wiring for these functions being catered for on the Facility Port. The maximum total Cat 5/6 cable length should not exceed 100 m.

Connections:

LM-2: The LM-2's upper PCB is fitted with an RJ45 connector labelled **OUTPUT**. Connect this to the **FACILITY PORT** using screened Cat 5/6 cable with screened RJ45 connectors at each end. Follow the colour coding shown in the table on page 19. The metal screening of the connectors should be bonded to the screen of the cable. Full details can be found in the LM-2 Installation Guide.

As explained in the preceding section, before the LM-2's music source and level controls will operate (in Zone 1 only), the **Z1 LOCAL/REMOTE** button [20] must be set to **REMOTE**.

BT-1: Connect the RJ45 socket on the rear of the BT-1 to the **FACILITY PORT** with *screened* Cat 5/6 cable and shielded RJ45 plugs. Full details can be found in the BT-1 Installation Guide.

M-1 and L-1: Connect the RJ45 socket on the rear of the M-1 or L-1 to the **FACILITY PORT** with *screened* Cat 5/6 cable and shielded RJ45 plugs. Full details can be found in the Installation Guide supplied with the module.

The Facility Port may alternatively be used as an additional balanced line input for any other source; see page 22 for details.

Music Mute (Fire Alarm Interface)

In some installations (such as licensed premises or retail outlets within a shopping mall), there may be a local authority or fire service requirement to mute the music signals from a fire alarm control panel when an alarm condition arises. 24 Series mixer-amplifiers include a facility to mute the music signals only (i.e., mic inputs are still active), via the **MUSIC MUTE** input. This is a 2-pin 5 mm-pitch screw terminal connector [26] on the rear panel.

Activation of the Music Mute is often via a relay mounted close to the mixer-amplifier, powered by the fire alarm control panel. Other arrangements may exist depending on the design of the fire control system and the alarm system details should be consulted when making the connection. The **MUSIC MUTE** input is non-isolated and connection should only be made to isolated contacts such as on a relay or mechanical switch. The mixer-amplifier will mute the music on either a contact closure at the Music Mute input (N/O) or an open-circuit (N/C). Selection of N/O or N/C operation is made with internal jumper J2. N/O is the factory default.

REMOTE MUSIC MUTE TERMINATIONS

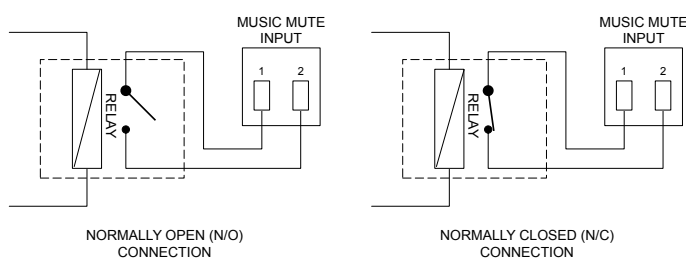

Note that any signal applied to the Facility Port – either from a remote active module, or as a hard-wired direct input, will also be muted by the action of Music Mute.

When Music Mute is active, the front panel red **MUSIC MUTE** LED [5] illuminates.

Auto Power Down

A Cloud 24 Series mixer-amplifier is extremely energy-efficient, but can be made even more so by enabling the Auto Power-Down feature. When active, the signal level is constantly monitored and if no signals from either zone output are measured for 15 minutes, the unit enters a “Sleep” mode, minimising power consumption. If a signal is detected while in Sleep Mode, the unit “wakes up” in approximately two seconds: if the signal is due to a line input, the volume will be faded up over a period of three seconds.

Units are shipped with the Auto Power Down function disabled. It may be enabled by removing internal jumper J10. See page 25 for location of PCB jumpers.

Options and Additional Information

Multi-zone Applications

Where the sound system specification calls for separate control in several zones, multiple 24 Series mixer-amplifiers can be used.

Signal sources can be parallel-connected to several inputs as required, but care must be taken to ensure the output stage of the signal source is capable of driving the resulting lower input impedance.

The impedance of the line inputs (music inputs) is greater than 10 kohms and it is reasonable to assume that most op-amp based signal sources are able to drive lower loads, allowing the line inputs on several amplifiers to be paralleled without any issues. The input impedance of the mic inputs is 3.3 kohms, making them suitable for microphones with a nominal impedance of 600 ohms or less. A single 600 ohm microphone could therefore typically be connected to four paralleled mic inputs.

If these guideline figures cannot be adhered to, the use of suitable mic or line distribution amplifiers is recommended.

To avoid any problems associated with differences in mains supply earthing, we recommend that all 24 Series mixer-amplifiers used in a multi-zone application should be co-located and connected to a common mains supply.

Note that when using multiple 24 Series mixer-amplifiers in a 19” rack, suitable ventilation arrangements must be made to ensure that lower amplifiers do not cause those above to overheat (see Ventilation at page 13 for further information)..

Control of music source and level via external DC

It may be necessary in some installations to adjust the music level and select music source in one or both zones from an external AV control system. If the **REMOTE** port(s) are not required for RL-1/RSL-6 Series remote control plates, they may be used to receive DC voltages from the external system to effect these adjustments.

Both music source selection and level can be controlled over their full ranges with a DC voltage of 0 to +3.3 V. The pinout of the **REMOTE** port is as follows:

PIN	USE
1	0 V ref.
2	Music level control (0 to +3.3 V)
3	Music source selection (0 to +3.3 V)

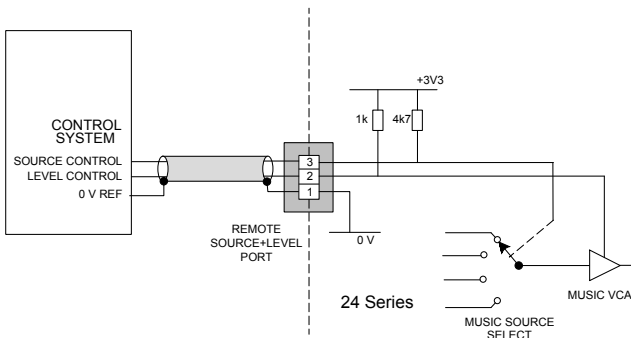

NOTE: If the control voltage source is not isolated from the power earth, there is a small risk of creating a 'ground loop' by linking the mixer technical ground (0 V) to the ground (0 V) of the equipment supplying the control voltages. To minimise this risk, we suggest that all pieces of equipment be in close proximity, and supplied from the same power outlet.

Music level

Music level in a zone may be varied over its full range by applying a DC voltage of between 0 V and +3.0 V to pin 2, the 0 V reference being connected to Pin 1. 0 V on pin 2 corresponds to maximum level and +3.0 V will produce 90 dB of attenuation. The rate of attenuation is approximately 33 mV/dB.

Note that there is an internal 1k "pull-up" resistor between pin 2 and the internal +3.3 V rail. If pin 2 is left "floating", this pull-up will result in full attenuation. The output impedance of the control voltage source should be low enough to overcome the effect of this resistor.

Music source

Music source for a zone may be controlled by applying various DC voltages of between 0 and +3.3 V to pin 3, the 0 V reference being connected to pin 1. A voltage of +1.8 V or less at pin 3 will select Line input 4 and one of 3 V will select Line input 1. The other line inputs will be selected with intermediate voltages. Taking pin 3 above +3 V will deselect all inputs, making the zone effectively 'off' for music.

The table below lists the DC voltages required at pin 3 to select each line input. The third column is the value of a resistor which should be connected between pins 1 and 3 to permanently 'force' a zone to a particular line input. Note that the values in the table are only correct when PCB jumpers J6 and/or J8 are in the default RSL-4 position.

INPUT	DC VOLTAGE	RESISTOR VALUE
OFF	>+3.2 V	Open-circuit
Line 1	+1.95 V	6k8
Line 2	+1.5 V	3k9
Line 3	+0.9 V	1k8
Line 4	0 V	Short-circuit

Note that there is an internal 4k7 "pull-up" resistor between pin 3 and the internal +3.3 V rail. If pin 3 is left "floating", this pull-up will cause 'OFF' to be selected. The output impedance of the control voltage source should be low enough to overcome the effect of this resistor.

Using the Facility Port as an auxiliary input

The Facility Port can route an audio source to either Zone 1, or to both zones, depending on the setting of internal PCB jumper J3. If the port is not connected to a remote input module it can be used as an additional, balanced line input. The signal applied at the Facility Port is mixed with the other music inputs but is NOT affected by the rear panel **MUSIC EQ** controls [12]. The Facility Port signal has no independent level control; level should be adjusted at the source. If Mic-over-Music priority is enabled (see "Paging control and mic priority" on page 16), a line input at the Facility Port will be reduced in level by 25 dB in the same way as the other Line Inputs, though this may be overridden by moving internal jumper J4 from its default setting (ON) to OFF. See page 25 for locations of PCB jumpers.

Connect an external balanced source to the Facility Port as shown below:

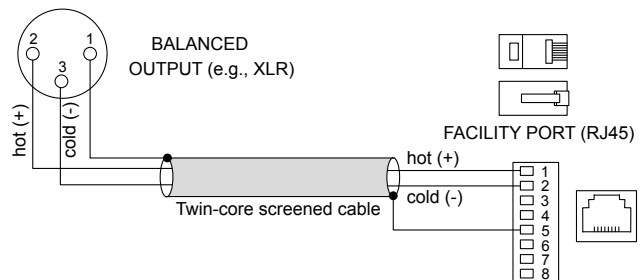

An unbalanced source may also be connected; the use of balancing transformers is recommended.

24 SERIES SERIAL CONTROL

24 Series mixer-amplifiers are equipped with a bi-directional RS-232 serial interface.

As a receiver, the interface permits external control of many mixer-amplifier settings. These include:

- Music Source selection in each zone
- Music level control in each zone
- Mic level control in each zone
- Mic muting in each zone

Note that the rear panel Remote/Local switches ([20] at page 11) must be set to Remote to enable RS-232 control.

The mixer-amplifier appears as a DCE (Data Communications Equipment) device to controlling equipment. As the controlling device will probably be configured as a DTE device, this requires the use of a straight (uncrossed) cable with the Tx (Data Transmit) pins at the cable ends connected to each other and the Rx pins (Data Receive) similarly connected to each other.

The full RS-232 protocol is beyond the scope of this manual, but is available for download from www.cloud.co.uk. This section provides only serial port details and an abridged serial command list.

Port parameters:

Parameter	VALUE/SETTING
Data type:	RS-232 serial
Data speed	9600 baud*
Word length	8 bits
Parity	None
Stop bits	One

*The default baud rate of 9600 baud may be altered by sending the appropriate RS-232 commands; details are in the RS-232 protocol document.

Abridged command set

The commands listed in the table below are some of those most commonly required when controlling a 24 Series mixer-amplifier from an AV control system. For all other commands, data requests and responses, please refer to the 24 Series' full RS-232 protocol document.

GENERAL FORMAT	
FUNCTION	COMMAND (ASCII)
Route Line Input x to Zone y	<Z y .MU , S x />
Set music level in Zone y to $-m$ dB	<Z y .MU , L m />
Reduce music level in Zone y by p dB	<Z y .MU , LD p />
Increase music level in Zone y by q dB	<Z y .MU , LU q />
Mute mic input for Zone y	<Z y .M1 , M/>
Unmute Mic input for Zone y	<Z y .M1 , O/>
Set mic level in Zone y to $-m$ dB	<Z y .MI , L m />
Reduce mic level in Zone y by p dB	<Z y .MI , LD p />
Increase mic level in Zone y by q dB	<Z y .MI , LU q />

Examples

1. Music source selection:

The values of x and y in the general format are the Line Input No. (1 to 4) and the Zone No. (1 or 2) respectively.

EXAMPLE	COMMAND (ASCII)	COMMAND (HEX)
Select Input 3 in Zone 2	<Z2 .MU , S3/>	3C 5A 32 2E 4D 55 2C 53 33 2F 3E

2. Music levels:

Levels can either be set in a specified zone to an absolute value (in dBs), or increased/decreased by a specified number of dBs. Either may be defined in steps of 1 dB.

For absolute levels, the number of dBs corresponds to attenuation rather than gain, thus 0 dB is maximum level and at -90 dB the zone is muted. The values of y in the general format is the Zone No. (1 or 2) and m is the attenuation level in one-dB steps (0 to 90) respectively.

To alter the zone level by a specified amount, the additional ASCII characters 'U' (up) or 'D' (down) are added to the string. The values of y , p and q in the general format are the Zone No. (1 or 2), the level increase in one-dB steps (0 to 90), or the level decrease in one-dB steps (0 to 90) respectively. A command to increment the level by a number of dBs greater than the current attenuation will set the level to maximum. Similarly, a command that would decrement the level below 90 dB attenuation will mute the Zone output.

EXAMPLE	COMMAND (ASCII)	COMMAND (HEX)
Set level in Zone 2 to -12 dB	<Z2 .MU ,L12/>	3C 5A 32 2E 4D 55 2C 4C 31 32 2F 3E
Reduce level in Zone 1 by 10 dB	<Z1 .MU ,LD10/>	3C 5A 31 2E 4D 55 2C 4C 44 31 30 2F 3E
Increase level in Zone 2 by 6 dB	<Z2 .MU ,LU6/>	3C 5A 32 2E 4D 55 2C 4C 55 36 2F 3E

3. Mute/Unmute Mics

The 24 Series mixer-amplifier's mic input may be enabled or disabled. This may be done on a per-zone basis or globally (both zones).

EXAMPLE	COMMAND (ASCII)	COMMAND (HEX)
Mute mic in Zone 2 only	<Z2 .M1 ,M/>	3C 5A 32 2E 4D 31 2C 4D 2F 3E
Unmute mic in Zone 2 only	<Z2 .M1 ,O/>	3C 5A 32 2E 4D 31 2C 4F 2F 3E
Mute mic globally	<MI ,M/>	3C 4D 49 2C 4D 2F 3E
Unmute mic globally	<MI ,O/>	3C 4D 49 2C 4F 2F 3E

APPENDIX

PCB jumper locations

24 Series mixer-amplifiers have various internal jumpers, the setting of which may require alteration during installation. The diagram below shows the locations of the internal jumpers (not to scale), all of which are located on the main PCB. The table below lists each jumper and its purpose, together with the factory default setting.

All "user" jumpers have two possible positions; the black rectangle in the symbol on the diagram below indicates the default setting. If any jumpers need to be changed, turn the unit off and disconnect it from the mains. Undo the seven screws securing the top cover of the unit (NB one is top centre of front panel) and remove it. Use a pair of small pliers to gently remove the jumpers from the PCB headers and reposition them as required. Refit the top cover using the same screws.

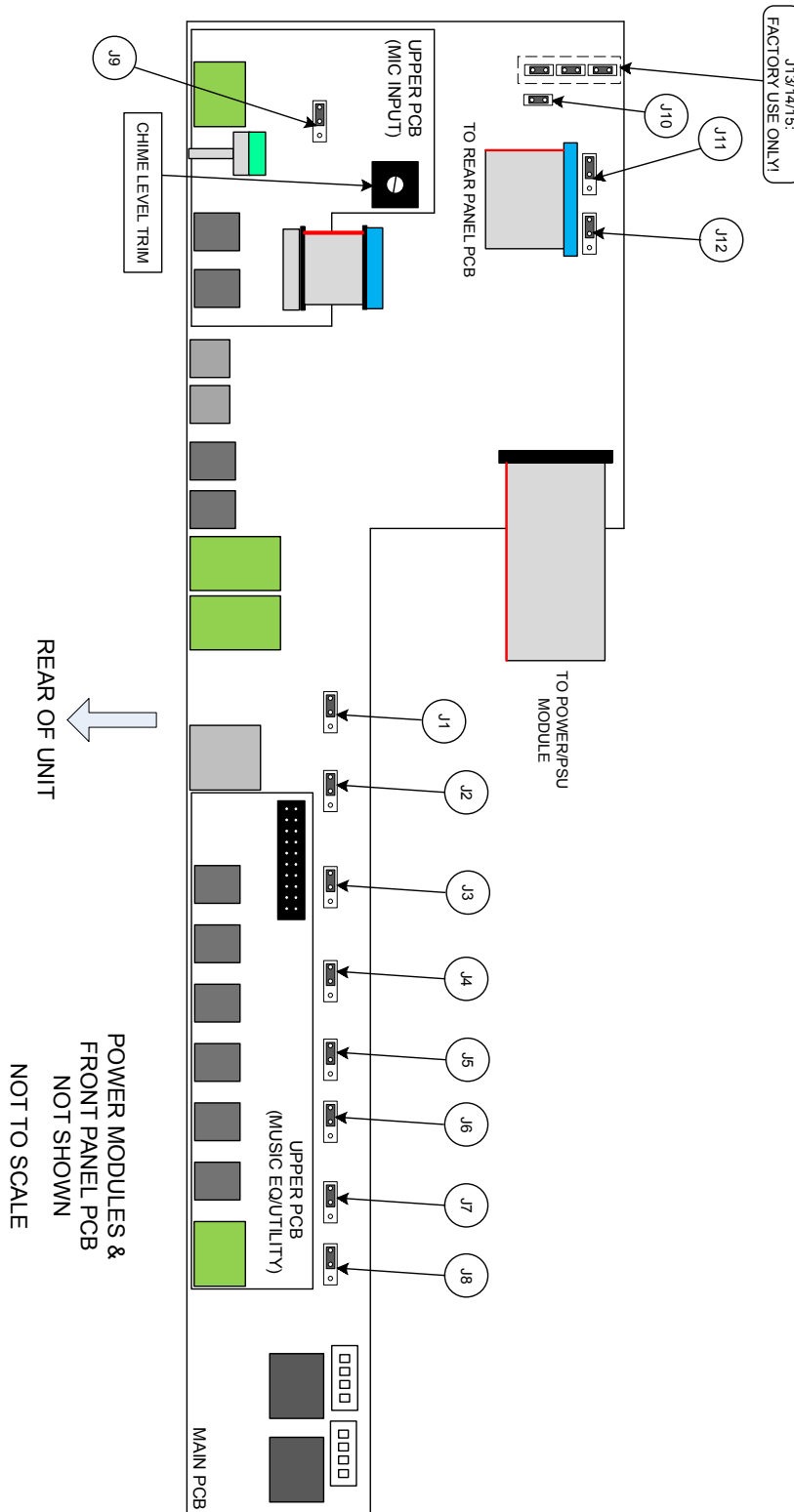

Table of internal jumpers and default settings

The table below lists each jumper and its purpose, together with location and factory default setting.

JUMPER	LOCATION	DESCRIPTION	EFFECT	DEFAULT
J1	Main PCB	Utility output music source	Z1: Music source for utility output is current Zone 1 selection. L1: Music source for utility output is always Line Input 1	Z1
J2	Main PCB	Music mute N/O or N/C	N/O: connect the pins of the MUSIC MUTE connector together to mute Line Inputs 1 to 4 and the Facility Port. N/C: remove a short-circuit across the pins of the MUSIC MUTE connector to mute Line Inputs 1 to 4 and the Facility Port.	N/O
J3	Main PCB	Facility Port audio routing	Z1: Audio input at Facility Port is routed to Zone 1 only. ALL: Audio input at Facility Port is routed to Zone 1 and Zone 2.	Z1
J4	Main PCB	Mic-over-Facility Port priority	DIS: The mic signal will be mixed at full level with the Facility Port input. EN: A signal at the mic input will cause a signal from the Facility Port to duck.	DIS
J5	Main PCB	Force Zone 1 front panel music source selection	SW: when Z1 LOCAL/REMOTE switch is set to REMOTE , front panel ZONE 1 MUSIC SOURCE switch is disabled and music source selection is made from remote control plate/module. FR: when Z1 REMOTE/LOCAL switch is set to REMOTE , front panel ZONE 1 MUSIC SOURCE control remains operative.	SW
J6	Main PCB	Zone 1 remote port type	RSL4: Remote music source/level control plate in Zone 1 is an RSL-4. RSL6: Remote music source/level control plate in Zone 1 is an RSL-6.	RSL-4
J7	Main PCB	Force Zone 2 front panel music source selection	SW: when Z2 LOCAL/REMOTE switch is set to REMOTE , front panel ZONE 2 MUSIC SOURCE switch is disabled and music source selection is made from remote control plate/module. FR: when Z2 REMOTE/LOCAL switch is set to REMOTE , front panel ZONE 2 MUSIC SOURCE control remains operative.	SW
J8	Main PCB	Zone 2 remote port type	RSL4: Remote music source/level control plate in Zone 2 is an RSL-4. RSL6: Remote music source/level control plate in Zone 2 is an RSL-6.	RSL-4
J9	Mic input sub-board	Mic Input phantom power	OFF: Mic Input phantom power off. ON: 12 V phantom power available at Mic Input.	OFF
J10	Main PCB	APD enable	PRESENT: APD (Automatic Power Down) inactive. ABSENT: APD enabled	PRESENT
J11	Main PCB	Zone 1 Line 4 Priority	DIS: Line Input 4 operates as other line inputs in Zone 1. EN: a signal at Line Input 4 will take priority in Zone 1 over all other Line Inputs, but not over the Facility Port.	DIS
J12	Main PCB	Zone 2 Line 4 Priority	DIS: Line Input 4 operates as other line inputs in Zone 2. EN: a signal at Line Input 4 will take priority in Zone 2 over all other Line Inputs, but not over the Facility Port.	DIS
J13	Main PCB	See separate JUMPER document (24_Series_JumperSettings) FOR FACTORY USE ONLY – DO NOT FIT A JUMPER HERE		ABSENT
J14	Main PCB			
J15	Main PCB			

Troubleshooting

Fault conditions are indicated by the front panel **STATUS LED** [6] flashing either red or green.

Status LED flashes GREEN - Output Power reduced

If the temperature of a power stage exceeds 70°C the output power to that zone will be reduced linearly to maintain a safe operating temperature for the internal components. This feature prevents over-temperature shutdown from being triggered and is indicated by a flashing **GREEN STATUS LED**.

Status LED flashes RED - Over-temperature Shutdown

When the amplifier temperature exceeds 85°C, the unit will mute the speaker and auxiliary outputs: this state is indicated by a flashing **RED STATUS LED**. This fault will self-clear when the cause is removed or rectified, i.e., improve ventilation, reduce input signal level, etc.

Output power reduction or over-temperature shutdown can occur if the amplifier is incorrectly installed. In this event, investigate the following points:

- Incorrect output setting for connected speaker load.
- Elevated ambient temperature (> 40°C)
- Ventilation requirements not met (e.g., blocked air vents)
- Excessive signal input (**PEAK LED** illuminated constantly)

Status LED flashes RED - Amplifier output protection

The Series 24 mixer-amplifier incorporates the following protection schemes to prevent damage to the amplifier or connected speakers:

- Short Circuit protection
- Over-current protection
- DC protection

If any of the three protection schemes is triggered, the unit will mute the speaker and auxiliary outputs and flash the **STATUS LED RED**. The speaker wiring should be checked for faults. Power cycling is required to reset the mixer-amplifier if DC is detected at the output terminals; otherwise the fault state will self-clear when the output current reduces.

EMC Considerations

Cloud Series 24 mixer-amplifiers fully conform to the relevant electromagnetic compatibility (EMC) standards and are technically well behaved. You should experience no problems interfacing units to other items of equipment and under normal circumstances, no special precautions need to be taken.

If the unit is to be used in close proximity to potential sources of HF disturbance such as high power communication transmitters, radar stations and the like, it is suggested that input signal leads be kept as short as possible.

Always use balanced interconnections wherever possible. If the mixer-amplifier is mounted in a 19" rack, do not locate the unit in close proximity to a powerful amplifier of any kind, which may radiate a strong magnetic field from the power transformer.

Earthing

When several mains powered units are connected together via their signal cables, there is a risk of one or more earth loops which may cause an audible hum on the system even with the gain controls set to minimum.

The 0 V rail of a Series 24 mixer-amplifier is directly coupled to the chassis ground. No interconnection problems should be encountered, but if there is any hum or other extraneous noise when source equipment is connected, the situation can generally be remedied by observing the following guidelines:

- Always connect sources using balanced connections wherever possible, with the cable screen only connected at the receiving end (amplifier input).
- Use audio isolating transformers (readily available from trade suppliers) at the inputs if necessary. These will ensure that the amplifier is electrically isolated from the source equipment.
- The signal source units should be located as close as possible to the amplifiers and the metal housing of the various units should not be electrically connected together through the equipment rack. If this is a problem, rack isolating kits are available from specialist hardware suppliers. If the problem persists, try to connect all interconnected units, including power amplifiers to a common power source to ensure a common ground is provided.

TECHNICAL SPECIFICATIONS

Line Inputs				
Frequency Response	20 Hz to 20 kHz, ± 1 dB			
Sensitivity	195 mV (-12 dBu) to 2.0 V (+8 dBu)			
Input impedance	>10 kohms (balanced/unbalanced)			
Headroom	12 dB			
Noise	<-90 dB (22 kHz bandwidth)			
Equalisation	HF: ± 10 dB @ 10 kHz; LF: ± 10 dB @ 50 Hz			
Microphone Input				
Frequency Response	-3 dB @100 Hz (fixed filter) to 20 kHz, ± 1 dB			
Sensitivity	2.54 mV (-50dBu) to 245 mV (-10 dBu)			
Input Impedance	3.3 kohms (balanced)			
Phantom Power	12 V, switchable per-input by jumpers			
Headroom	16 dB			
Noise (EIN)	<-126 dBu			
Equalisation	HF: ± 10 dB @ 5 kHz; LF: ± 10 dB @ 100 Hz			
Facility Input				
Frequency Response	20 Hz to 20 kHz, ± 1 dB			
Sensitivity	0.775 V (0 dBu)			
Input impedance	10 kohms (balanced)			
Headroom	18 dB			
Noise Gate	-60 dB			
Main Output				
Output Power (1 kHz continuous sine wave)	24-120	120 watts per zone nominal; 240 W total available in Power Sharing mode		
	24-240	240 watts per zone maximum		
Minimum load	Low-Z output	4 or 8 ohms		
	High-Z output	70 V-line	24-120 24-240	41 ohms 20.5 ohms
		100 V-line	24-120 24-240	66 ohms 33 ohms
	Frequency response	Low-Z output	20 Hz to 20 kHz, ± 1 dB	
High-Z output		20 Hz to 20 kHz, ± 1 dB (65 Hz filter off)		
THD + N	< 0.05% @ 1 kHz			
Protection	Fixed level signal limiter: DC, over-current and over-temperature protection			
Auxiliary Output				
Nominal output level	0 dBu (0.775 V _{rms}), balanced			
Noise	<-90 dB, 22 kHz bandwidth			
General				
Power input	Universal type, 85 to 265 VAC, 45 to 65 Hz			
Fuse details	24-120	5 x 20 mm, time delay, T4A		
	24-240	5 x 20 mm, time delay, T5A		
Normal operating temperature	0 °C to 35 °C (Note: performance and specifications cannot be guaranteed outside of this range)			
Cooling	Forced air cooling (front to side)			

Power consumption	Standby ¹	24-120	5.74 W (15.48 VA)
		24-240	5.88 W (24.92 VA)
	Idle ²	24-120	17.12 W (28.49 VA)
		24-240	18.74 W (36.11 VA)
	1/8 th Power ³	24-120	56.46 W (65.88 VA)
		24-240	90.79 W (108.99 VA)
1/3 rd Power ⁴	24-120	106.17 W (114.90 VA)	
	24-240	183.96 W (207.16 VA)	
Heat Loss	Standby ¹	24-120	20.67 kJ/hr (19.6 BTU/hr)
		24-240	21.17 kJ/hr (20.07 BTU/hr)
	Idle ²	24-120	61.63 kJ/hr (58.45 BTU/hr)
		24-240	67.46 kJ/hr (63.98 BTU/hr)
	1/8 th Power ³	24-120	102.71 kJ/hr (97.40 BTU/hr)
		24-240	124.17 kJ/hr (117.75 BTU/hr)
1/3 rd Power ⁴	24-120	136.95 kJ/hr (129.88 BTU/hr)	
	24-240	179.81 kJ/hr (170.52 BTU/hr)	
Dimensions (W x H x D)	Net	24-120	482.6 mm x 44 mm (1U) x 150 mm 19" x 1.75" (1U) x 5.9" (less connectors & knobs)
		24-240	482.6 mm x 44 mm (1U) x 230 mm 19" x 1.75" (1U) x 9.06" (less connectors & knobs)
	Shipping (Gross)	545 mm x 160 mm x 330 mm (21.5" x 6.3" x 13.0")	
Weights	Net	24-120	2.35 kg (5.26 lb)
		24-240	3.05 kg (6.83 lb)
	Shipping	24-120	3.4 kg (7.62 lb)
		24-240	4.1 kg (9.2 lb)

Notes re Power Consumption and Heat Loss measurements:

All measurements at 230 VAC 50 Hz power input

1. Standby: amplifier in standby state (STATUS LED steady red)
2. Idle: amplifier not in standby state (STATUS LED steady green), but no audio output
3. 1/8th. Power: constant sound level at one-eighth maximum rated output (audio mainly clean, only occasional clipping)
4. 1/3rd. Power: constant sound level at one-third maximum rated output (audio beginning to become compressed, limited or heavily clipped)

cloud

www.cloud.co.uk

MADE IN BRITAIN 