

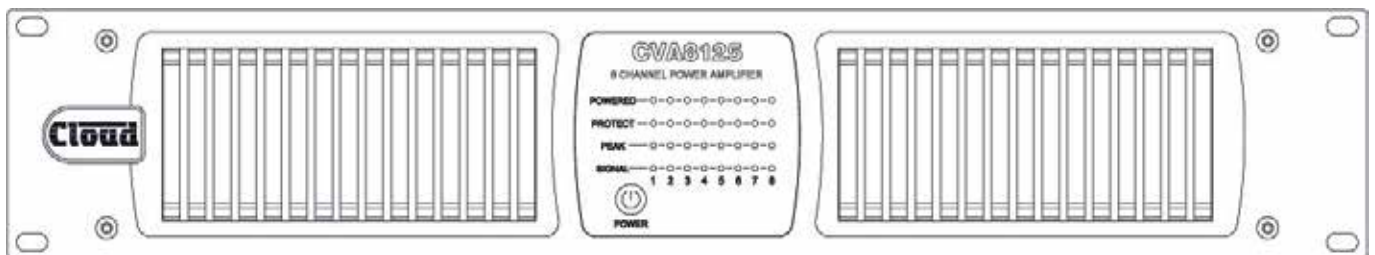

CVA SERIES DIGITAL AMPLIFIERS

MODELS: CVA2500/CVA4250/CVA8125





Installation and User Guide

WARNING:

To reduce the risk of fire or electric shock, do not expose this appliance to rain or moisture.

CAUTION:

| | |
|--|--|
|  <p>CAUTION RISK OF ELECTRIC SHOCK DO NOT OPEN</p> | <p>WARNING: SHOCK HAZARD – DO NOT OPEN AVIS: RISQUE DE CHOC ÉLECTRIQUE – NE PAS OUVRIR</p> |
|  | <p>The lightning flash with the arrowhead symbol within an equilateral triangle, is intended to alert you to the presence of uninsulated dangerous voltages within the product's enclosure that may be of sufficient magnitude to constitute a risk of electric shock.</p> |
|  | <p>The exclamation point within an equilateral triangle is intended to alert the user to the presence of important operating and maintenance (servicing) instructions in the literature accompanying the appliance.</p> |

IMPORTANT SAFETY INSTRUCTIONS

1. Read these Instructions.
2. Keep these Instructions.
3. Heed all Warnings.
4. Follow all Instructions.
5. Do not use this apparatus near water.
6. Clean only with a dry cloth.
7. Do not block any ventilation openings. Install in accordance with the manufacturers' instructions.
8. Do not install near any heat sources such as radiators, heat registers, stoves or other apparatus (including amplifiers) that produce heat.
9. Do not defeat the safety purpose of the polarized or grounding - type plug. A polarized plug has two blades with one wider than the other. A grounding type plug has two blades and a third grounding prong. The wide blade or the third prong are provided for your safety. When the provided plug does not fit into your outlet, consult an electrician for replacement of the obsolete outlet.
10. Protect the power cord from being walked on or pinched particularly at plugs, convenience receptacles, and the point where they exit from the apparatus.
11. Only use attachments/accessories specified by the manufacturer.
12.  Use only with the cart, stand, tripod, bracket or table specified by the manufacturer or sold with the apparatus, when a cart is used, use caution when moving the cart/apparatus combination to avoid injury from tip-over.
13. Unplug this apparatus during lightning storms or when unused for long periods of time.
14. Refer all servicing to qualified service personnel. Servicing is required when the apparatus has been damaged in any way, such as power-supply cord or plug is damaged, liquid has been spilled or objects have fallen into the apparatus, the apparatus has been exposed to rain or moisture, does not operate normally, or has been dropped.



Do not expose the apparatus to dripping or splashing, and ensure that no objects filled with water, such as vases, are placed on the apparatus.

L'appareil ne doit être exposé aux écoulements ou aux éclaboussures et aucun objet ne contenant de liquide, tel qu'un vase, ne doit être placé sur l'appareil.



The mains plug is used as the disconnect device and it should remain readily accessible during intended use. In order to isolate the apparatus from the mains, the mains plug should be completely removed from the mains outlet socket.

Le prise du secteur ne doit pas être obstruée ou doit être facilement accessible pendant son utilisation. Pour être complètement déconnecté de l'alimentation d'entrée, la prise doit être débranchée du secteur.



EU Declaration of Conformity

DATE OF ISSUE: 12th June 2018

MANUFACTURER: Cloud Electronics Limited

ADDRESS: 140 Staniforth Rd,
Sheffield,
S9 3HF. UK

PRODUCT NAMES: CVA8125EK, CVA8125NA, CVA8125AUS
CVA4250EK, CVA4250NA, CVA4250AUS
CVA2500EK, CVA2500NA, CVA2500AUS

PRODUCT TYPE: Line Amplifier

Cloud Electronics Ltd declare under our sole responsibility that the listed products comply with the requirements set out in the Council Directive **2014/35/EU** for electrical equipment used within certain voltage limits or Low Voltage Directive (LVD); and with the requirements of directive **2014/30/EU** for Electromagnetic Compatibility (EMC); and the CE Marking Directive **93/68/EEC & RoHS2 Directive 2011/65/EU**

For the evaluation of the compliance with these directives the following standards were applied:

Directive **2014/35/EU** (electrical equipment designed to be used within certain voltage limits);
Test Specification(s): **BS EN62368-1:2014**

Directive **2014/30/EU** (electromagnetic compatibility);
Test Specification(s): **BS EN55035:2017 (Immunity)**
BS EN55032:2015 (Emissions)
BS EN61000-3-2:2014 (Harmonics)

Cloud Electronics Ltd declare that the products produced under its brand name are designed and manufactured as professional audio products and therefore outside of the intended scope of the European Commission Regulations (EC) **1275/2008** of 17th Dec 2008 implementing Directive **2005/32/EC** of the European Parliament and of the Council with regards eco-design requirements for STANDBY and OFF mode electric power consumption of electrical and office equipment.

Place and Date Issued: Cloud Electronics Limited, 12th June 2018.

Simon Curtis,
Managing Director

REACH Directive; it's expected that our suppliers and business partners be aware of their obligations under REACH. Given those conditions, our current products are exempt from REACH pre-registration and later registration activities. We provide a separate EU Reduction of Hazardous Substances document for our RoHS compliant products.

The WEEE directive (2002/96/EC) places an obligation on all manufacturers and importers, trading in the EU, to take back electronic products at the end of their life. Cloud Electronics Ltd accepts the responsibility to finance the cost of disposing of such products. All our products are marked with the WEEE symbol; this indicates that these products must NOT be disposed of with other waste.

This document may not be changed or copied without authorisation

Contents

| | |
|--|-----------|
| SAFETY INFORMATION | 6 |
| Safety notes regarding installation..... | 6 |
| Conformities..... | 6 |
| RoHS and WEEE declaration..... | 7 |
| Safety Considerations and Information | 7 |
| Caution – High Voltage | 7 |
| Caution – Mains Fuse | 7 |
| Caution – Servicing | 7 |
| Overview | 7 |
| Introduction | 7 |
| Applicable Models..... | 8 |
| CVA Digital amplifiers - main features | 9 |
| Available Options..... | 9 |
| DSP functions..... | 9 |
| What’s in the Box..... | 9 |
| Block Diagram | 10 |
| Front Panel Description | 10 |
| Rear Panel Description | 11 |
| Installation | 12 |
| Mechanical | 12 |
| Ventilation..... | 12 |
| Power requirements and turning the amplifier on and off | 12 |
| Remote Power Down | 12 |
| Factory Reset..... | 13 |
| Amplifier Protection..... | 13 |
| Power sharing..... | 13 |
| Connections and Adjustments | 14 |
| Inputs | 14 |
| Input Routing..... | 14 |
| Outputs | 16 |
| 70/100 V-line operation..... | 16 |
| Low impedance operation..... | 16 |
| High Pass Filters..... | 16 |
| Level Control..... | 16 |
| Remote level control..... | 17 |
| Connecting an RL-1 Series remote control plate | 17 |
| Auxiliary Outputs..... | 17 |
| Ethernet Control of CVA Digital Amplifiers | 18 |
| OS and Browser compatibility | 18 |
| Checking browser compatibility..... | 18 |
| Configuring the network..... | 19 |
| Browser control..... | 19 |
| Audio pages..... | 20 |
| Audio pages – Overview | 20 |
| Audio pages - Channels..... | 21 |
| Input Routing tab | 21 |
| Room EQ tab | 21 |
| Speaker EQ tab..... | 23 |
| Output tab..... | 25 |
| Limiter tab..... | 25 |
| Audio pages – Auxiliary Outputs..... | 26 |
| Input Routing tab | 26 |
| Room EQ tab | 26 |
| Filter tab..... | 26 |
| Speaker EQ tab..... | 29 |
| Output tab..... | 29 |
| Limiter tab | 29 |
| Submenu: DSP Configuration | 30 |
| Stereo configurations..... | 31 |
| Stereo channels..... | 32 |
| Stereo Auxiliary Outputs 33 | 33 |
| Using Crossovers | 33 |
| 2-Way Mono Crossover | 33 |
| 2-Way Stereo Crossover + Mono | 36 |
| 2-Way Stereo Crossover + Sub..... | 38 |
| Using the Auxiliary Outputs with Crossovers | 40 |
| Other Menus and Submenus | 41 |
| Monitoring..... | 41 |
| Status tab..... | 41 |
| Rear Panel Controls tab..... | 41 |
| Temperature tab..... | 41 |
| Event Log..... | 42 |
| The Config Menu | 42 |
| Submenu: User Security | 43 |
| Guest User..... | 44 |
| Submenu: Networking..... | 45 |
| TCP/IP Address tab..... | 45 |
| Identity tab | 45 |
| Reset and Upload | 45 |
| Server Ports tab..... | 45 |
| SNMP tab..... | 45 |
| Submenu: Clock / Calendar | 46 |
| Date / Time tab..... | 46 |
| Scheduler tab..... | 46 |
| Submenu: General..... | 47 |
| Submenu: GPIO..... | 47 |
| Submenu: Logging | 47 |
| Submenu: Labelling..... | 48 |
| Submenu: Delay Configuration..... | 49 |
| Submenu: Save/Load Config | 49 |
| Submenu: Change Installer PIN | 50 |
| Submenu: Device Info | 50 |
| Additional Amplifier Functions | 50 |
| The GPIO Port..... | 50 |
| GPIO Inputs..... | 50 |
| GPIO outputs..... | 50 |
| Serial Control of CVA Digital Amplifiers..... | 51 |
| Pinout..... | 51 |
| Port parameters | 51 |
| Block numbers..... | 51 |
| Abridged command set | 52 |
| Examples | 52 |
| Using the amplifier as an Ethernet-to-serial bridge | 53 |
| APPENDIX | 54 |
| RL-1 Series remote control plates – general considerations..... | 54 |
| Control of audio level via external DC | 54 |
| Technical Specifications | 55 |
| Table of factory settings | 57 |

SAFETY INFORMATION

Safety notes regarding installation

- Do not expose the unit to water or moisture.
- Do not expose the unit to naked flames.
- Do not block or restrict any air vent.
- Do not operate the unit in ambient temperatures above 35 °C.
- Do not touch any part or terminal carrying the hazardous live symbol ⚡ while power is supplied to the unit.
- Do not perform any internal adjustments unless you are qualified to do so and fully understand the hazards associated with mains operated equipment.
- The unit has no user serviceable parts. Refer any servicing to qualified service personnel.
- If the moulded plug is cut off the AC power lead for any reason, the discarded plug is a potential hazard and should be disposed of in a responsible manner.

Conformities

This product conforms to the following European EMC Standards:

BS EN55035:2017 (Immunity)

BS EN55032:2015 (Emissions)

BS EN61000-3-2:2014 (Harmonics)

This product has been tested for use in commercial and light industrial environments. If the equipment is used in controlled EMC environments, the urban outdoors, heavy industrial environments or close to railways, transmitters, overhead power lines etc. the performance of the unit may be degraded.

This product conforms to the following electrical safety standard:

BS EN 62368-1:2014

RoHS and WEEE declaration

Cloud Electronics Limited manages its business and collaborates with its suppliers to comply with the European Union restriction of the use of certain hazardous substances in electrical and electronic equipment, RoHS Directive (2002/95/EC), that came into force on 1st July 2006, and similar restrictions in other jurisdictions.



The “crossed out wheellie bin” symbol on the product and represented above is there to remind users of the obligation of selective collection of waste. This label is applied to various products to indicate that the product is not to be thrown away as unsorted municipal waste. At the end of life, dispose of this product by returning it to the point of sale or to your local municipal collection point for recycling of electric and electronic devices.

Customer participation is important to minimize the potential effects on the environment and human health that can result from hazardous substances that may be contained in this product.

Please dispose of this product and its packaging in accordance with local and national disposal regulations, including those governing the recovery and recycling of waste electrical and electronic equipment. Contact your local waste administration, waste collection company or dealer.

Safety Considerations and Information

All models in the Cloud CVA Digital range must be earthed. Ensure that the mains power supply provides an effective earth connection using a three-wire termination.

Caution – High Voltage

Do not touch any part or terminal carrying the hazardous live symbol while power is applied to the unit. Terminals to which the hazardous live symbol refers require installation by a qualified person.

Caution – Mains Fuse

The CVA Digital amplifier contains no user-replaceable fuses. Mains over-current protection is provided by the fuse on the rear panel; only replace this fuse with one of an identical type and rating.

The fuse rating is 8 A, type T8A 250 V. The fuse body size is 20 mm x 5 mm.

Caution – Servicing

The unit contains no user-serviceable parts. Refer servicing to qualified personnel. Do not perform servicing unless you are qualified to do so. Disconnect the power cable from the unit before removing the top panel and do not make any internal adjustments with the unit switched on. Only reassemble the unit using bolts/screws identical to the original parts.

Overview

Introduction

Cloud CVA digital amplifiers are versatile multi-channel power amplifiers of advanced design, able to drive 100 V line or 70 V line and low-impedance 4Ω / 8Ω / 16Ω loudspeaker systems directly. They are ideal for sound reinforcement applications in the retail, leisure, hospitality, commercial or industrial sectors. Large installations using multiple amplifiers will benefit from the amplifiers’ network connectivity: each amplifier may be configured individually, controlled and monitored remotely over a standard Ethernet network.

All CVA Digital amplifiers are capable of delivering 1 kW of audio power. Only in 70 V line and 100 V line modes, this maximum power rating can be shared between channels in an intelligent manner, allowing the amplifiers to drive different types or numbers of loudspeakers in the various areas of a building or venue with maximum economy. The range comprises four models, which differ only in the number of channels. The figure in the “Power” column below represents the power that can be delivered when all channels are equally driven:

| MODEL | CHANNELS | POWER |
|---------|----------|-----------|
| CVA2500 | 2 | 2 X 500 W |
| CVA4250 | 4 | 4 X 250 W |
| CVA8125 | 8 | 8 X 125 W |

All models include on-board, user-configurable DSP permitting great flexibility of internal architecture, but an important aspect of the design is that the amplifiers emulate earlier Cloud amplifier designs “out-of-the-box”, and it is not necessary to either connect a computer nor remove the lid to set an amplifier’s basic configuration for 100 V line or 4Ω operation. Ethernet, RS-232 and DC remote control options are provided: the amplifiers are fully compatible with standard Cloud remote control plates.

CVA Series amplifiers can be used on an Audinate Dante™ AoIP network with the addition of a CDI-CVA digital input card, available as a separate retrofittable option. CDI-CVA cards are available in 2, 4 and 8-channel versions, and fit the rear panel expansion bay. Full installation and configuration instructions are supplied with each card. Visit www.cloud.co.uk, navigate to **Resources** -> **Manuals** for full information.

Particular design attention has been paid to the amplifiers’ energy efficiency. The Class D output stages dispense with line output transformers, and consequently offer great savings in weight and size over earlier designs. An automatic power-down (APD) feature puts the amplifier into an ultra-low-current standby mode if no input signal has been detected for 30 minutes; in this mode the power consumption is approx. 2.5 W. The amplifiers also include a remote standby/wake up function, enabling them to be placed into standby mode - and subsequently powered-up again - by a simple external contact closure.

Safety features of the design include output DC detection, overcurrent protection, and thermal monitoring / limiting. A switch-on delay provides loudspeaker protection at power-up. All models use variable-speed forced-air cooling.

Applicable Models

This Installation Guide describes the installation and operation of the following models only:

- Cloud CVA2500: 2-channel amplifier, 70/100 V line and low-impedance outputs, total rating 1 kW
- Cloud CVA4250: 4-channel amplifier, 70/100 V line and low-impedance outputs, total rating 1 kW
- Cloud CVA8125: 8-channel amplifier, 70/100 V line and low-impedance outputs, total rating 1 kW

Wherever the term “CVA Digital amplifier” or simply “amplifier” is used in this manual, it may be assumed that the information is applicable to all the above models. Where information is specific to one (or more) models only, clear reference to the relevant model type(s) will be made.

NOTE: Amplifier models CA2500, CA4250, and CA8125 are NOT covered by this Guide.

CVA Digital amplifiers - main features

- Transformerless output stage drives 70/100 V-line and 4Ω / 8Ω / 16Ω low impedance systems directly
- Standard "out-of-the-box" Cloud amplifier functionality: requires no computer configuration or internal access for basic operation at 100 V-line or 4Ω
- Extensive set of DSP functions for advanced configuration
- Balanced line level inputs
- Per-channel output level controls
- Per-channel rear panel input switches for input routing, low- / high- impedance operation and high-pass filter
- Balanced, line level auxiliary outputs with full channel functionality
- Automatic Power Down: <3 W power consumption with all channels quiescent
- Serial remote control via RS-232C port or Ethernet
- Compatible with standard Cloud RL Series remote level control plates
- Remote Power control input
- GPIO port
- Variable speed forced-air cooling
- Thermal protection, overcurrent limiting and DC offset protection
- Switch-on delay for speaker protection during power-up
- Universal PSU – operates from 100 to 240 VAC

Available Options:

- CDI-CV Dante™ digital input card, available in 2, 4 and 8-channel versions. Full details can be found at

<https://www.cloud.co.uk/accessory/cdi-cv8-optional-8ch-dante-card-for-cv-amplifier>

<https://www.cloud.co.uk/accessory/cdi-CV4-optional-4ch-dante-card-for-CVA-amplifier>

<https://www.cloud.co.uk/accessory/cdi-CV2-optional-2ch-dante-card-for-CVA-amplifier>

- RL-1 remote level control plate
- EQ presets for OEM speakers (under development)

DSP functions:

- On-board, per-channel DSP section providing extensive routing, filtering, EQ and limiting for all channels including the auxiliary outputs
- 1.5 s delay pool, freely assignable across all channels and aux outputs
- Simple DSP configuration via on-board web server; any device with a compatible web browser and an Ethernet connection can be used to perform setup
- Built-in DSP crossover configurations allow amplifiers to be easily used with 2-way speakers
- Crossover configurations allow derived LF sub output
- 5-band parametric speaker EQ section
- Separate 7-band Room EQ section
- Fully swept high-pass filter for speaker protection
- Password-protected multi-user security system

What's in the Box

Please check the shipping carton for damage before opening. If there is damage, please contact your Cloud agent and the shippers.

The packing carton should contain the following items:

- Cloud CVA Digital amplifier
- Set of mating plug-in screw-terminal connectors
- Quick Start Guide
- Mains cable(s)

Block Diagram

BLOCK DIAGRAM IN "OUT OF THE BOX" MODE
 ADVANCED FEATURES, ROUTING AND E.Q. ARE AVAILABLE THROUGH THE WEB INTERFACE.

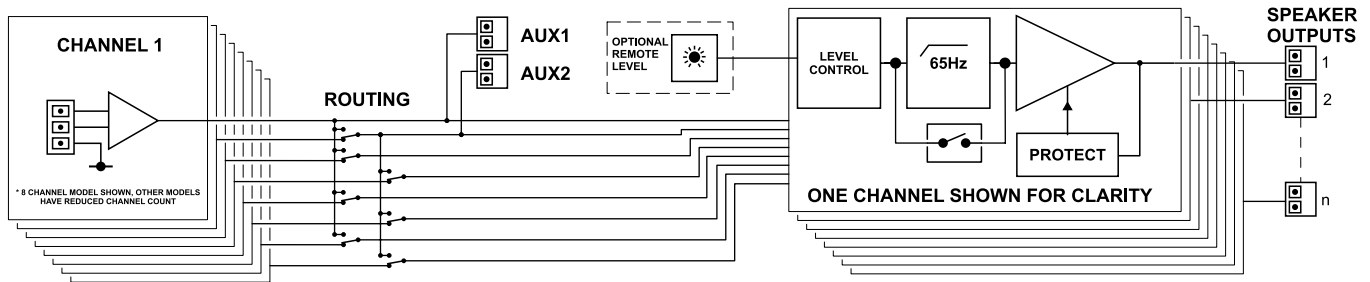

Front Panel Description

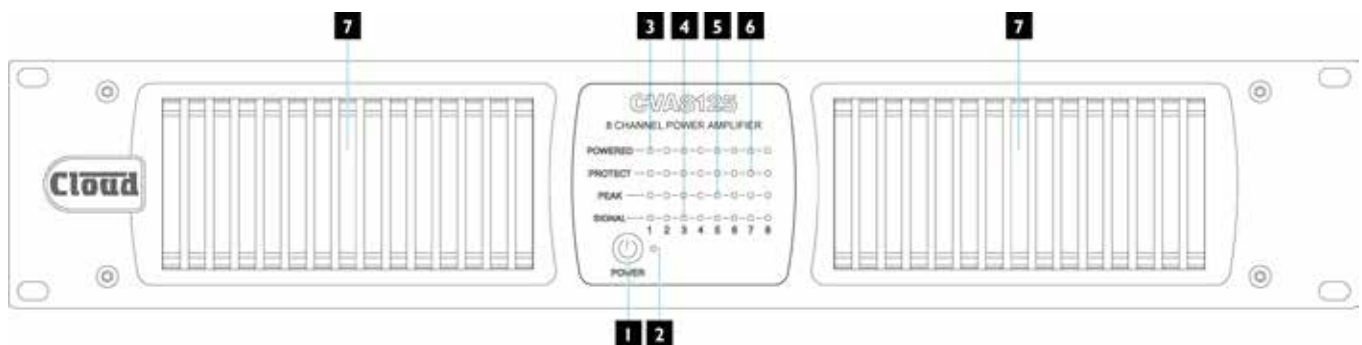

1. **POWER** – press to turn the amplifier on: a subsequent press will turn the amplifier off.
2. **POWER LED** (green) – illuminates when the amplifier is powered, either in its active state or in Automatic Power Down (APD) mode.

Each amplifier channel has four LEDs on the front panel, which function as follows:

3. **POWERED** (green) – illuminates when the channel is active, i.e., it has been “woken up” when the input signal level exceeds -77 dBu (typical threshold: may vary with programme type). Flashes slowly when a channel is subject to thermal limiting.
4. **SIGNAL** (green) – illuminates when the output signal level from the amplifier channel is at least 30 dB below the rated output level.
5. **PEAK** (yellow) – with the channel’s limiter enabled (the factory default setting), the LED illuminates when the limiter is active, i.e., reducing gain. With the limiter disabled, the LED illuminates when the amplifier is clipping: this will normally indicate that the signal level is too high. Note that the limiter settings are accessed via the browser control pages.
6. **PROTECT** (red) – indicates a fault condition. It illuminates when the power amplifier stage is shut down by the internal protection circuitry, which will occur if excessive current or DC is detected at the output terminals, or if the internal temperature becomes too high. Over-current or DC fault conditions can be cleared by removing the AC power supply for a few seconds, but when the cause is over-temperature, the amplifier will remain in its protected state until the temperature drops (which will generally occur if the input signal is reduced).
7. Ventilation intakes – these should always be unobstructed when the amplifier is in use.

Rear Panel Description

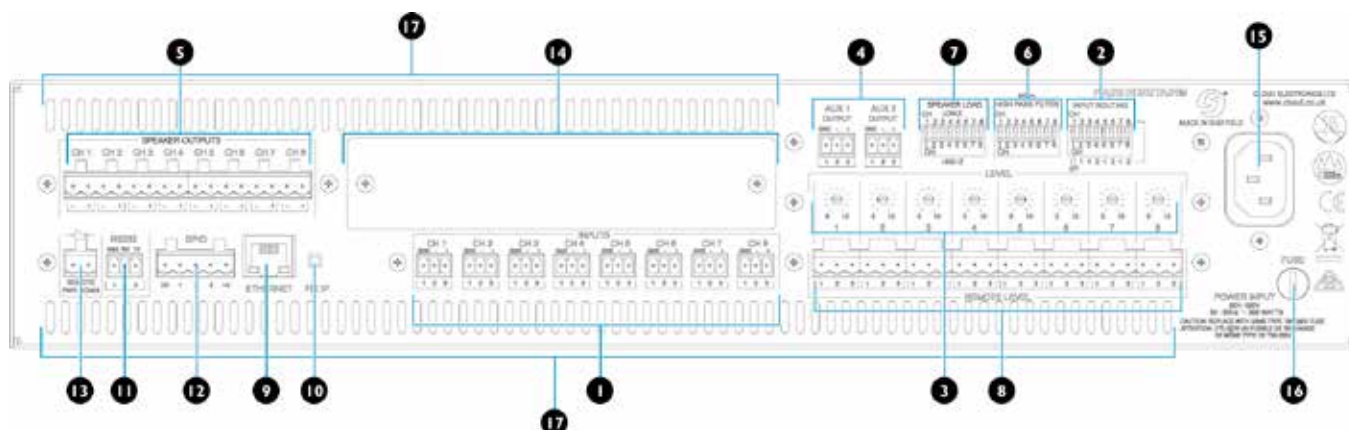

- 1. INPUTS CH 1 ... CH n** – one 3-pin, 3.5 mm-pitch screw-terminal connector per amplifier channel. The inputs are balanced. Connect the amplifier sources here.
- 2. INPUT ROUTING** – a 2-, 4- or 8-way DIP switch depending on model. The factory default setting is with all switches up: in this state each amplifier channel will be fed by the same-numbered input connector. See page 14 for full description of function. Note that SW1 is inactive on all models.
- 3. LEVEL** – one recessed preset-type control per channel: adjusts the output level of the channel.
- 4. AUX 1 and AUX 2** – two 3-pin, 3.5 mm-pitch screw-terminal connectors. May be used to drive additional amplifiers, for recording or other purposes. The outputs are balanced and derived “post” the relevant **LEVEL** control. The factory default sources for the **AUX 1** and **AUX 2** are the signals routed to the inputs of amplifier Channels 1 and 2 respectively; thus **AUX 2**’s source will be affected by the setting of **INPUT ROUTING** DIP switch SW2. The web browser pages allow full control over the source, level, EQ and other parameters of the auxiliary outputs.
- 5. SPEAKER OUTPUTS** – one 2-pin, 5 mm-pitch screw-terminal connector per amplifier channel. Connect the feeds to the loudspeaker systems here.
- 6. 65 Hz HIGH PASS FILTER** – a 2-, 4- or 8-way DIP switch depending on model. The factory default setting is with all switches down and filters active. The factory default filter frequency is 65 Hz: frequencies below this will be removed. The frequency may be adjusted to a different value via the web browser pages.
- 7. SPEAKER LOAD** – a 2-, 4- or 8-way DIP switch depending on model. CVA Digital amplifiers may be used with either 70 / 100 V-line high-impedance, or 4Ω / 8Ω / 16Ω low-impedance systems. The factory default setting is with all switches down, for high-impedance operation. High-impedance mode is configured for 100 V-line operation from the factory, but can be changed via the DSP configuration.
- 8. REMOTE LEVEL** – one 3-pin, 5 mm-pitch screw-terminal connector per amplifier channel. Cloud RL-1 Series remote control plates may be connected here, to permit the output level of each channel to be controlled from a remote location. An external DC voltage source (0 to 10 V) may also be applied from an external control system.
- 9. ETHERNET** – a standard RJ45 Ethernet port. Connect to a computer, tablet, wi-fi point or LAN to access the amplifier’s web browser pages.
- 10. FIX IP** – a recessed push-button; if it is held pressed while the amplifier is powered on, the amplifier’s IP address is fixed at 192.168.0.253. This is intended to allow an engineer easy access to the web browser pages without the use of the Cloud Network Discovery Tool.
- 11. RS232** – a bi-directional RS-232C serial interface on a 3-pin, 3.5 mm-pitch screw-terminal connector. Most amplifier functions may be controlled via this port.
- 12. GPIO** – a 3-way GPIO port on a 5-pin, 5 mm-pitch screw-terminal connector. The ports are configured via the web browser pages and each may be configured for master muting, fault reporting or other user functions.
- 13. REMOTE PWR DOWN** – a 2-pin, 5 mm-pitch screw-terminal connector allowing remote control of the amplifier’s Automatic Power Down (APD) function. A contact closure at this connector will force APD, placing the amplifier in Standby Mode with very low power consumption.
- 14. Expansion bay** – an optional CDI-CVA Series digital input card may be fitted here to permit integration with a Dante™ network.
- 15. AC input** – standard IEC receptacle. Use the AC power cable supplied with the amplifier.
- 16. FUSE** – 8A 20 mm mains fuse. Only replace the fuse with one of an identical type.
- 17. Ventilation exhausts** – these should always be unobstructed when the amplifier is in use.

Installation

Mechanical

The amplifiers are designed to be mounted in a standard 19" equipment rack. The front panel is fitted with rackmount ears for this purpose. All models require 2U of vertical rack space. See notes below regarding spacing and ventilation.

Due to the units' weight, the use of rack side rails is recommended.

Ventilation

CVA Digital amplifiers are force cooled by an internal, thermostatically-controlled fan: temperature is sensed within the amplifiers' power output modules. The fan is inoperative at temperatures below 25°C. Above this temperature its speed is determined by the hottest amplifier module and increases proportionately to a maximum speed when the highest module temperature reaches 85 °C.

Always allow adequate space around the amplifier to allow a free flow of air through the unit. Ensure that cable bundles or other items do not obstruct any vents.

The airflow intake is at the front panel (filtered), with exits in the rear and left-hand side panels. It is recommended not to mix CVA Digital amplifiers with other equipment employing forced-air cooling which acts in the opposite direction within the same rack.

CVA Digital Series amplifiers have been designed to operate in an ambient temperature range of 0 °C to 35 °C. While satisfactory operation outside of this recommended temperature range may be achievable in a particular installation, no guarantee can be given regarding full adherence to the performance specifications (see the Appendix section of this manual).

Installers should always endeavour to fit the CVA Digital Series amplifier in a location where the recommended temperature range is not exceeded.

CVA DIGITAL AMPLIFIERS: SIMPLE AND ADVANCED OPERATION

CVA Digital Series amplifiers are designed to work "out-of-the-box", and for many installations the basic factory configuration will provide satisfactory and adequate operation. In such installations, an Ethernet connection need not be provided.

In other installations, the installer may wish to access the amplifier's DSP section to take advantage of the many additional configuration options it provides, including sophisticated EQ, extra routing possibilities and limiting. He/she may also wish to make the amplifier's web control pages available to the user. For this reason, configuration and control via the Ethernet connection is covered in a separate section of this Guide: see "Ethernet Control of CVA Digital Amplifiers" on page 18. Installers not requiring the additional functionality can ignore this section.

Power requirements and turning the amplifier on and off

Connect the CVA Digital amplifier to AC mains using the supplied IEC cable. The amplifier will operate on supply voltages from 85 to 265 V, 50 or 60 Hz.

The power button  is a "soft" type; press once to turn the amplifier on. All front panel LEDs will illuminate for a few seconds while internal diagnostics are conducted. The green LED adjacent to the power button will remain on after this sequence.

The amplifier is highly energy efficient and has an Automatic Power Down (APD) feature, which puts individual channels into Standby Mode after 30 minutes if no input signal to the channel has been detected. If no input signals are present when the amplifier is turned on, all channels will go immediately into Standby Mode. The power consumption in Standby Mode is approximately 2.5 W.

Press the power button again to turn the amplifier off.

If the mains supply is interrupted while the amplifier is on, the amplifier will execute the boot/diagnostic sequence automatically when power is restored.

Remote Power Down

The amplifier may be "forced" into Standby Mode applying a short-circuit to the rear panel **REMOTE PWR DOWN** connector. The connector is a 2-pin, 5 mm-pitch screw-terminal type. The amplifier will "wake up" when the short-circuit is removed: wake-up time is typically 200 ms. This function can be useful in shutting down e.g., visitor attractions at museums and theme parks.

Factory Reset

A “long” press on the power button when the amplifier is off will effect a Factory Reset. This will cancel any user configurations that have been loaded, including DSP assignments, enablement of rear panel switches, channel and DSP Block names, etc. Hold the power button down until the adjacent Power LED flashes (approx. 5 seconds) to perform the Factory Reset; on releasing it, the amplifier will carry out it its normal boot sequence.

See “Table of factory settings” on page 55 for a list of the primary Factory settings.

Amplifier Protection

CVA Digital amplifiers’ output stages incorporate comprehensive protection circuitry to prevent damage to loudspeakers, the output devices and other components in the event of a fault condition.

The voltage and current at the output terminals of each channel is constantly monitored and the channel will enter Protection Mode and shut down if either DC or excessive current is detected. In this case, the relevant front panel **PROTECT** LED will illuminate. Power-cycling the amplifier by removing the IEC power connector and replacing it after 5 seconds will normally clear the fault condition, but if the **PROTECT** LED remains lit after the boot sequence, the amplifier may have developed a fault, and should be serviced.

The internal temperature of the power modules is also constantly monitored, and if a temperature of 85°C is reached, the channel will enter Protection Mode. Other amplifier channels will be unaffected. A thermally-induced protection state is normally an indication that the amplifier channel is being driven too hard, and reducing the input signal level will generally clear the fault. Once the temperature of an amplifier channel module, or that of its PSU, reaches 80°C, a progressive thermal limiter will activate to gradually reduce gain by up to 6dB and reduce the likelihood of thermal shutdown. The relevant channel front panel **POWERED** LED will flash slowly to indicate the onset of thermal limiting. Thermal limiting will cease when the temperature reduces below 75°C.

The protection circuitry is also activated immediately the amplifier is powered on. This is to prevent any voltage spikes due to start-up conditions from damaging the loudspeakers. The protection circuitry automatically times out after a short delay. All **PROTECT** LEDs illuminate at switch-on during the boot sequence: this is normal.

Power sharing

This is currently applicable to 70 / 100 V-line use - channels set to low-impedance mode should be considered to be allocated the nominal channel wattage as determined by the amplifier model: CVA2500: 500W, CVA4250: 250W and CVA8125: 125W. Therefore, low-impedance channels should have this wattage subtracted from the 500W total of the odd or even channel group to which they belong, before allocating the remainder across the remaining high-impedance channels.

All models use two separate internal power supplies, each rated at 500 W. The two supplies serve the odd- and even-numbered channels respectively. Each amplifier channel is capable of delivering 500 W, but this figure can only be realised if *the other channels in its group (of odd or even-numbered channels) are unused*. As other channels in the same group are called upon to deliver power, the maximum power available from any one channel is reduced. If all channels are simultaneously driven with equal input levels, and the **LEVEL** controls are adjusted to the same setting, the maximum, multi-channel power rating of the amplifiers can be stated as follows:

- CVA2500: 2 channels, 500 W/ch
- CVA4250: 4 channels, 250 W/ch
- CVA8125: 8 channels, 125 W/ch

The great advantage of the power sharing principle is that it allows installers to use some channels to drive speakers in areas where only low power is needed, and others for areas where more is needed.

It should be apparent that the 2 channel CVA2500 is largely independent of the power sharing principle, having only one odd and one even channel.

Connections and Adjustments

Inputs

Each amplifier channel has an electronically-balanced input on a 3-pin, 3.5 mm-pitch screw terminal connector **1**. Twin-core screened cable should be used when driving the amplifier inputs from a device with a balanced output. Single-core screened cable can be used when connecting to an unbalanced source.

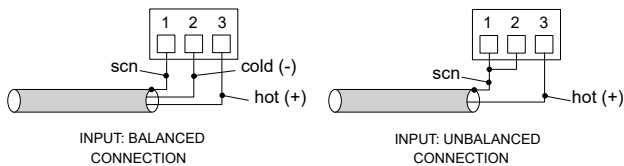

Input Routing

In common with other Cloud power amplifiers, each amplifier channel can either be fed with a signal from its own input (the factory default setting), or with the signal feeding another channel. This allows the same input signal to feed several channels without the need for input connectors to be wired in parallel. CVA Digital models with fewer channels are obviously restricted in the range of routing options available in comparison with models with more channels.

The rear panel **INPUT ROUTING** DIP switches **2** are used to select input source for each channel, except Channel 1. The factory default setting is with all switches UP, which connects the input to each amplifier channel to the same-numbered input connector, as indicated on the upper row of numbers. Setting a switch DOWN parallels the input of that amplifier channel with the input of the amplifier channel indicated below the switch.

Note:

- Switch 1 is inoperative on all models.

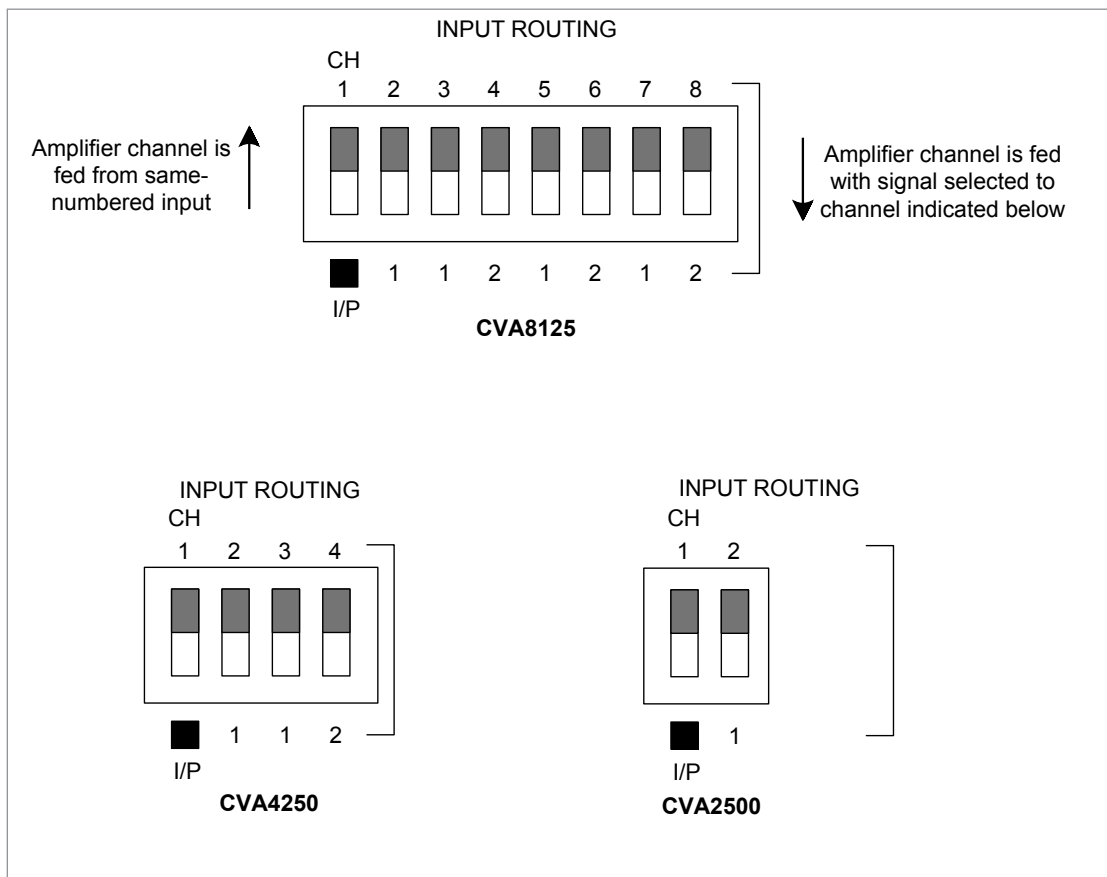

The input routing switches operate in the manner shown in the schematics below.

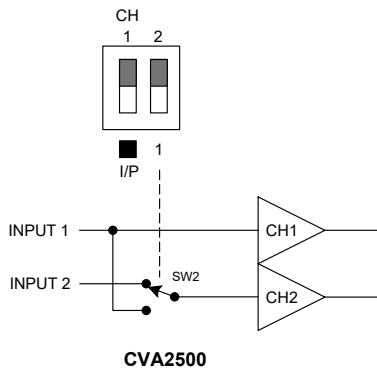

CVA2500

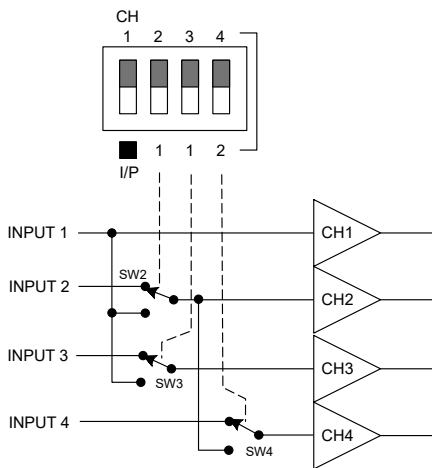

CVA4250

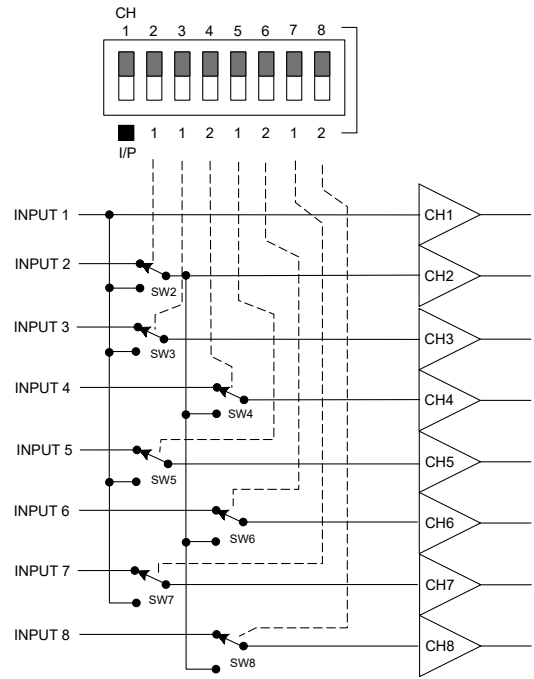

CVA8125

For all CVA Digital models, the routing options may be summarised as follows:

- all amplifier channels may be sourced by the same-numbered input
- Channel 2 may be sourced from either Input 1 or Input 2
- odd-numbered channels from Channel 3 upwards may alternatively be sourced from Input 1
- even-numbered channels from Channel 4 upwards may alternatively be sourced with whichever input is selected for Channel 2

Outputs

The speaker output connector for each amplifier channel is a 2-pin, 5 mm-pitch screw-terminal type ⑤. The plug-in connectors are suitable for cable cores up to 2.5 mm².

Connect as shown below:

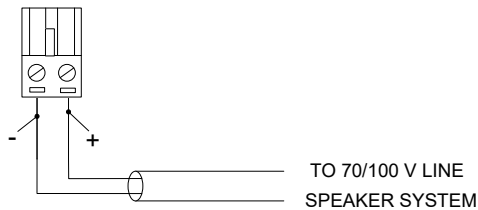

⚠ Never make connections to the output terminals while the amplifier is powered.

70/100 V-line operation

CVA Digital amplifiers can drive either 100 V-line or 70 V-line loudspeaker distribution systems. 70 / 100 V-line (high-impedance) mode is set on the rear panel SPEAKER LOAD DIP switch, and the choice of 70 V-line or 100 V-line is made using the DSP Output Configuration page. ⑦. The DIP switch size varies with model. The example shown below is for the 4-channel CVA4250; the principle is identical across the range.



4/8/16Ω operation

CVA Digital amplifiers can additionally drive low-impedance loudspeaker systems. Low-impedance mode is set on the rear panel SPEAKER LOAD DIP switch, and the choice of 4Ω, 8Ω or 16Ω impedance is made using the DSP Output Configuration page.

High Pass Filters

Most transformers fitted to 70/100 V-line speakers exhibit core saturation when fed with high-level signals at low frequencies. Transformer saturation creates unpleasant distortion and stresses the system. To counteract this, a correctly configured high pass filter is an essential part of any line distribution system. CVA Digital amplifiers have a high pass filter in each channel, selectable via the **HIGH PASS FILTER** DIP switch on the rear panel ⑥. The DIP switch size varies with model. The example shown below is for the 4-channel CVA4250; the principle is identical across the range.

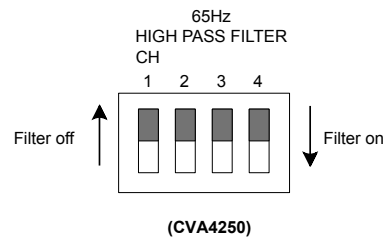

The factory default filter frequency is 65 Hz, which should be satisfactory for many installations; however the frequency can be adjusted over the full audio bandwidth from the web browser pages. Note also that the DIP switch may be disabled, on a per-channel basis, from the web browser pages.

Low impedance operation

The channel output will be optimised for use with the low-impedance load of either four, eight, or sixteen ohms, as chosen via the DSP Output Configuration page. In the 4 Ω setting the load impedance must not be less than four ohms, in the 8 Ω setting the load impedance must not be less than eight ohms and in the 16 Ω setting the load impedance must not be less than sixteen ohms. However, higher impedances may be driven in all cases, though the maximum power output of the amplifier channel will be reduced proportionately.

Check the impedance of the loudspeakers to be driven by the amplifier; if using multiple loudspeakers, employ series/parallel wiring as appropriate to ensure the combined impedance is not less than the impedance set via the DSP Configuration page.

The power capability of an amplifier in low impedance mode should be taken to be the nominal channel power level for the particular amplifier model, assuming the load impedance matches that set via the DSP Output Configuration page. For example, a low-impedance channel of a CVA8125 should be considered to be loading its power supply with 125W.

Level Control

Control of audio level in each channel is provided by the rear panel preset rotary **LEVEL** control ③. It should be appreciated that this adjusts the signal level feeding the amplifier power stage and is thus essentially an output level control, not an input level or sensitivity control. The preset should be adjusted using a trim tool or small screwdriver. Zero output is obtained with the control fully anti-clockwise. Full output level is with the control fully clockwise; at this setting the maximum output voltage (dependent on channel output mode) will be produced for an input signal level of 0.775 V_{rms} (0 dBu).

We recommend that the level for each channel should be set after installation is complete by commencing with the **LEVEL** controls at minimum. Installers should ensure that adequate, but not excessive sound levels are achieved with the programme material that will be used in practice.

Note that the web browser pages for each channel include an “enable” switch for the rear panel **LEVEL** control and **REMOTE LEVEL** port; the factory default setting for this switch enables both functions.

Remote level control

Like many other Cloud products, CVA Digital amplifiers allow remote control of audio level in each channel. Cloud remote control plates from the RL-1 Series provide an elegant solution, though control via a DC voltage from third-party systems is also possible (see "Control of audio level via external DC" on page 52).

RL-1 plates connect via the **REMOTE LEVEL** port for the relevant channel 8. Each channel uses a 3-pin 5 mm-pitch screw terminal type connector. When connected, an RL-1 plate will adjust the channel level between zero (fully anticlockwise: channel muted) to the maximum level (fully clockwise) determined by the setting of the rear panel **LEVEL** control.

Note that the web browser pages for each channel include an "enable" switch for the rear panel **LEVEL** control and **REMOTE LEVEL** port; the factory default setting for this switch enables both functions.

Please refer to "RL-1 Series remote control plates – general considerations" on page 52 for additional information.

Connecting an RL-1 Series remote control plate

Wire the remote control plate as shown below, using twin-and-screen cable. Maximum reliable cable run is 100 m.

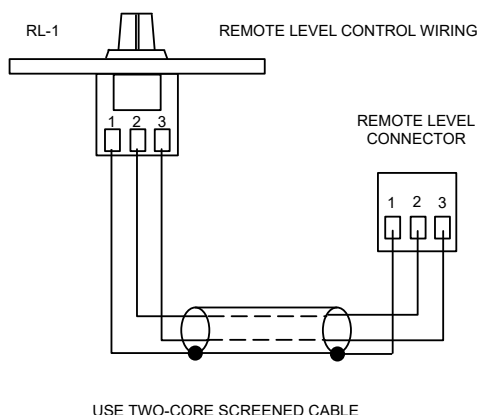

Auxiliary Outputs

The amplifier is provided with two Auxiliary Outputs, **AUX 1** and **AUX 2** 4. These may be used to drive additional amplifiers, for recording, or any other purpose where system "expansion" is required. The connectors are 3-pin, 3.5 mm-pitch screw terminal type.

The signals at the auxiliary outputs are balanced and line level, and can thus be used to drive most external equipment directly. The connector pinout is identical to that used for the amplifier inputs:

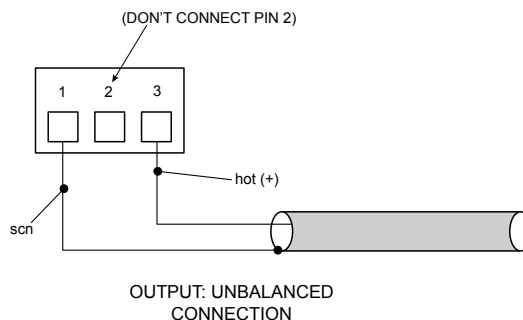
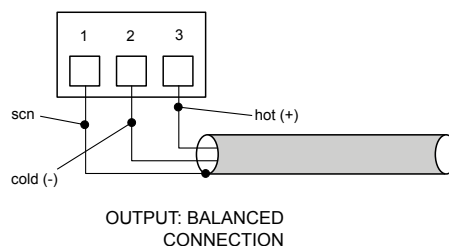

"Out-of-the-box", the factory default sources for outputs **AUX 1** and **AUX 2** are the signals routed to Channels 1 and 2 respectively. It can be seen from the Block Diagram (page 10) that in practice this means that **AUX 1** will always carry the signal applied to **INPUT 1**, and **AUX 2** will always carry the signal selected by **INPUT ROUTING** DIP switch 2 - either that applied to **INPUT 1** or that applied to **INPUT 2**.

Note also that by default, the sources for the Auxiliary Outputs are effectively derived "post" the rear panel channel **LEVEL** controls. Therefore the output level at **AUX 1** and **AUX 2** will be affected by the **LEVEL** controls for Channels 1 and 2 respectively, and also by any RL-1 remote control plate connected to the **REMOTE LEVEL** ports for those channels.

It should be noted that internally, the Auxiliary Outputs have extensive DSP facilities (e.g., input routing, extensive EQ, limiting) almost identical to those in the main amplifier channels, but of course, without a power output stage. The web browser pages allow the Auxiliary Outputs to be configured with the same degree of flexibility as the main channels. See "Audio pages – Auxiliary Outputs" on page 26 for full details.

Ethernet Control of CVA Digital Amplifiers

CVA Digital amplifiers have a server function, which makes control pages available in a browser running on any device on the same network as the amplifier. This allows the installer to access the amplifiers' DSP functions, making a greatly extended range of features and control options available. It also permits easy configuration and real-time control of the amplifier from any convenient device on the network.

OS and Browser compatibility

The CVA Digital amplifier uses standard TCP/IP and UDP-based networking protocols, and is therefore broadly compatible with modern desktop and mobile operating systems.

Checking browser compatibility

The Web Browser-based user interface requires HTML5, CSS3, localStorage and WebSockets support, which are provided as standard in current Web browsers.

If there is any doubt regarding browser compatibility, Cloud recommends the use of the website html5test.com to check which features your browser supports.

Configuring the network

NOTE: This section of the manual is intended for those with a working understanding of basic computer network configuration and the terminology involved.

Ethernet connection to the CVA Digital amplifier can be simplified by the use of the Cloud Ethernet Discovery Tool. This can be downloaded from www.cloud.co.uk; navigate to **Resources** and select **Downloads** in the resource selector. The Discovery Tool is available in two distinct versions:

- an executable JAR file, which will run on Linux, Windows or Mac systems within a Java Runtime Environment (available from www.java.com)
- a Windows-specific application, which does not require Java.

Download the most appropriate version for your operating system, and save it in a convenient location.

There are three methods of establishing network communication:

1. During initial setup, the amplifier may be connected directly to a laptop Ethernet interface, using either a straight or crossover Ethernet cable. In this scenario, both the laptop and amplifier will configure themselves using Link-local IP addresses and will be able to communicate without the requirement for DHCP, or further network infrastructure. Using this temporary connection, the amplifier can be set up and configured to use either DHCP (the default) or a specific, static IP address suitable for the target network. If a static IP address is to be used, Subnet Mask and Gateway must

also be set correctly. If Gateway details are unknown, the value 0.0.0.0 can be used safely.

2. Alternatively, the amplifier may be connected to a spare port of an Ethernet switch on an existing network, and set up from any device on the same network. In this scenario, DHCP is the expected method for IP address allocation during the initial setup procedure. If the network does not support DHCP, then the direct-connection method described above should be used to assign the correct static IP address first.
3. Press the rear panel **FIX IP** button **10** while powering the amplifier on with the **POWER** button **1**. This forces the amplifier to adopt the temporary static address 192.168.0.253, and a direct Ethernet connection to a laptop or tablet may be used. The amplifier can then be located on a browser by entering this IP address in the URL field, provided the device in use is configured with a static IP address in the 192.168.0.xxx range (where xxx is in the range 1 to 254). The IP address will revert to that previously-saved at the next power-down/power-up cycle (unless the network settings have been deliberately altered).

For methods 1 and 2, run the Discovery Tool; this will open the window shown below, which should contain an entry with the amplifier model in the **Name** column.

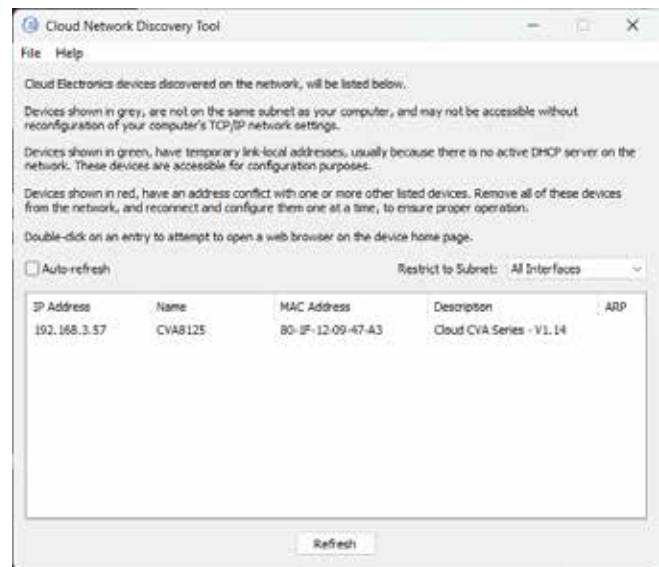

NOTE: If a warning message appears referencing Windows Firewall, it can be safely ignored by closing the message box.

Double-click on the CVA Digital amplifier entry. This should open your default browser and make the login page visible.

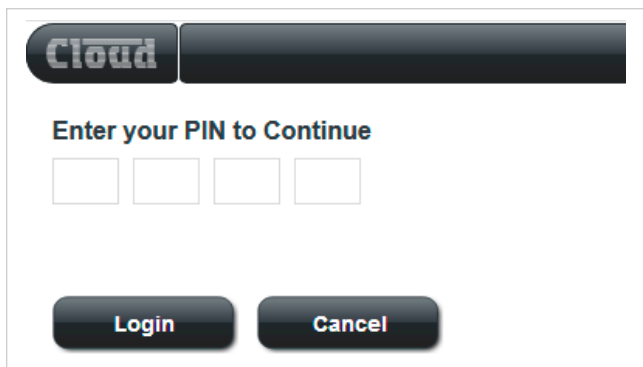

The image shows a login screen with the 'Cloud' logo in the top left. Below the logo is a dark bar with the text 'Enter your PIN to Continue'. Underneath this are four empty square input boxes for the PIN. At the bottom of the screen are two buttons: 'Login' and 'Cancel'.

Enter the Installer PIN (the factory default is 1234*) to authorise access. Click **Login** and the **Audio: Overview** page will be displayed:

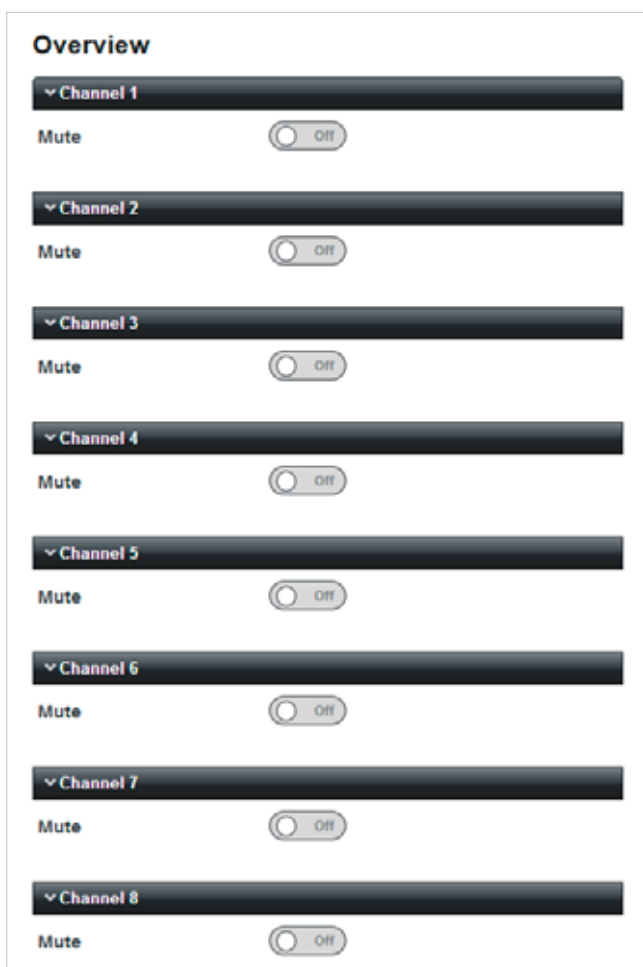

The image shows the 'Overview' page for audio channels. It has a title 'Overview' at the top. Below it are eight sections, each for a channel (Channel 1 to Channel 8). Each section has a 'Mute' label and a toggle switch. All toggle switches are currently in the 'Off' position.

NOTE: For security, the server has a time-out of two minutes; if no browser activity occurs within this time, it reverts to the login page and the PIN will need to be re-entered. A **Logout** option is also provided in the main menu.

Click the menu icon at the right-hand end of the **Installer** banner and now select **Config**, followed by **Networking**. This will open the **Network Configuration** page:

* It is recommended that the factory default PIN is changed to something less obvious when installation is complete. See "Submenu: Change Installer PIN" on page 48.

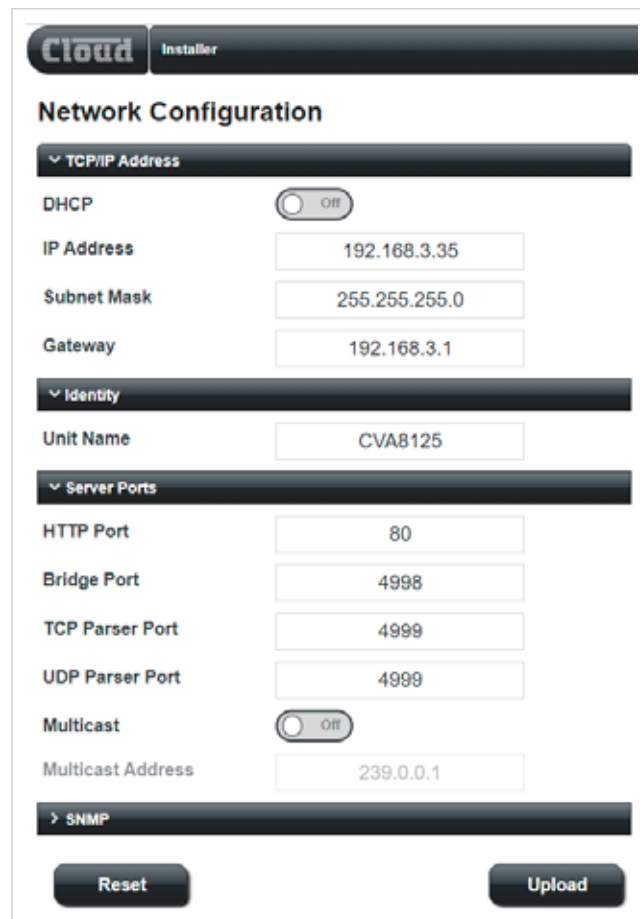

The image shows the 'Network Configuration' page. At the top is the 'Cloud' logo and 'Installer' text. The title is 'Network Configuration'. There are three main sections: 'TCP/IP Address', 'Identity', and 'Server Ports'.
 - **TCP/IP Address:** DHCP is set to 'Off'. IP Address is 192.168.3.35, Subnet Mask is 255.255.255.0, and Gateway is 192.168.3.1.
 - **Identity:** Unit Name is CVA8125.
 - **Server Ports:** HTTP Port is 80, Bridge Port is 4998, TCP Parser Port is 4999, and UDP Parser Port is 4999. Multicast is set to 'Off' and Multicast Address is 239.0.0.1.
 At the bottom, there is a '> SNMP' section and two buttons: 'Reset' and 'Upload'.

We recommend that the amplifier should either be set with a static IP address (i.e., with DHCP set to **Off**), or uses a fixed DHCP allocated-address on your routing hardware. It will then have a fixed IP address on the network for other devices to browse to. Ensure that a suitable IP address is reserved on the network to which you intend to connect the device. If the amplifier changes IP address, users or third-party control applications may not be able to locate it. (Installers may need to consult the client's IT Manager for guidance.)

Note that when **DHCP** is set to **On**, values in the **IP Address**, **Subnet Mask** and **Gateway** fields are set automatically and the fields are no longer modifiable.

Browser control

Once the network has been set up as described above, the amplifier's extended function set may be controlled remotely from a web browser running on a computer or other device anywhere on the same network.

Click the menu icon  on the title bar at any time to see the main drop-down menu.

Audio pages

Control and configuration of the amplifier's audio functions is done via the Audio pages, selected from the main menu. Click the menu symbol  to open the drop-down menu, and select **Audio** (example below from CVA8125) and select an amplifier channel:

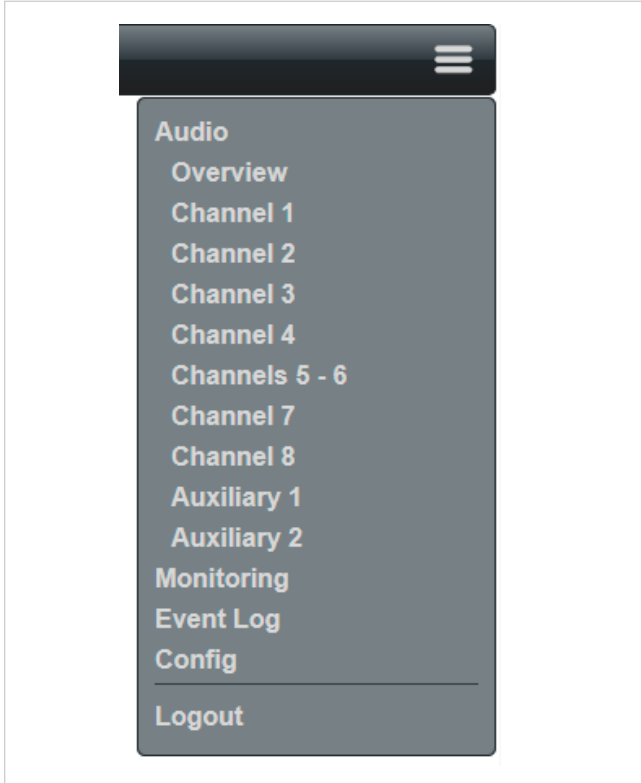

NOTE:

In addition to the Overview page, each amplifier channel and each of the two Auxiliary Outputs has its own page: if channels are grouped together as a "DSP block" for stereo or crossover operation, a single page for that block of channels will be available, the various parameters then being applicable to all channels in the group. This section of the manual describes the use of the Audio page for a single mono channel.

See "Submenu: DSP Configuration" on page 28 for details of grouping channels for stereo or crossover operation.

Audio pages – Overview

This page is the "landing" page, which is always first displayed after log-in. It provides a single-page summary of the channel input source, output level and mute status for all amplifier channels and the Auxiliary Outputs (if enabled to do so).

The page has a separate tab for each amplifier channel and Auxiliary Output, which can be opened or closed by clicking on the tab name bar. By default, all tabs are open:

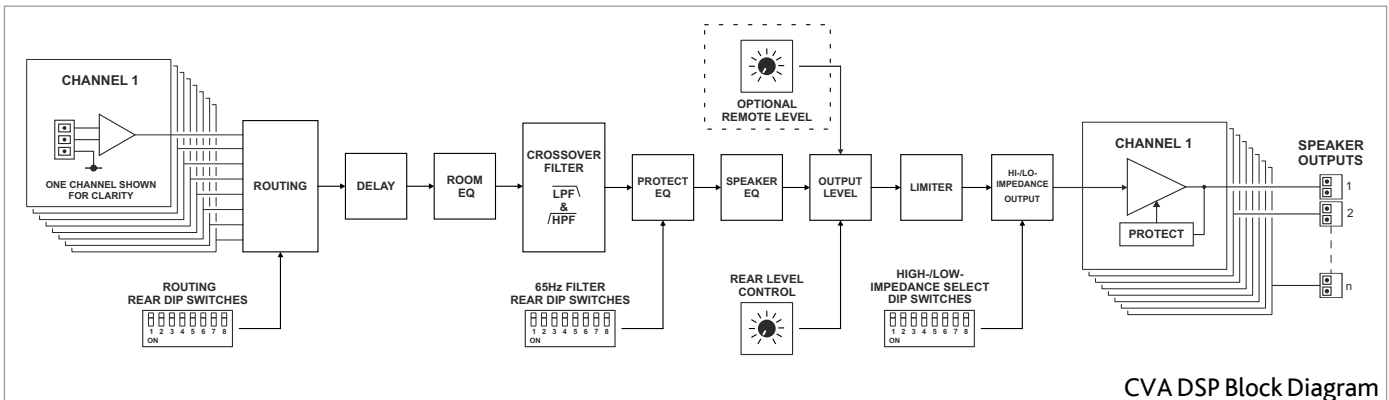

The “out-of-the-box” default shows a **Mute** switch for each of the main amplifier channels. Two additional functions may be added for each channel: the source selection switch and the output level control. This will only be displayed if corresponding rear panel hardware controls are disabled: that is, if their functions have been assigned to software. This assignment is made on the individual Channel pages by setting the **Rear Panel** switches under the **Input Routing** and **Output** tabs to **No**. The example below shows the **Overview** page when Channels 1 and 2 have both source selection and output level selected for software control:

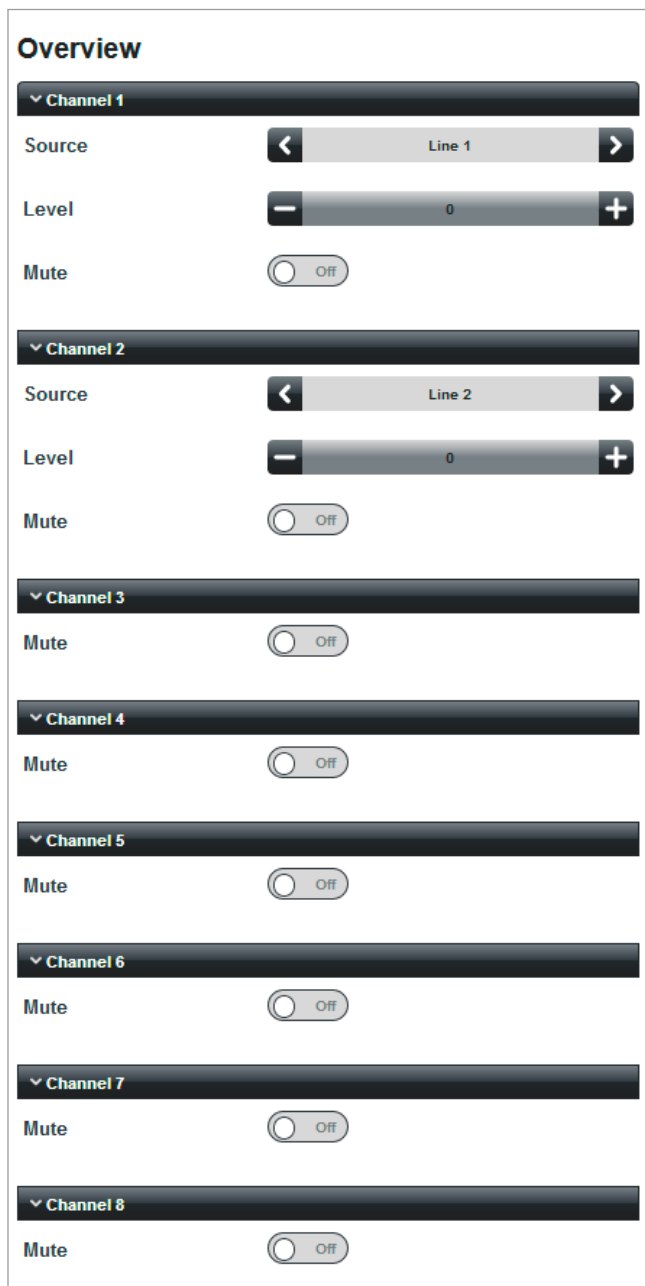

Now, each channel can be muted or unmuted by clicking on its **Mute** switch, but Channels 1 and 2 can also have their source and output level viewed and/or adjusted from the **Overview** page.

A full description of the per-channel Audio pages follows.

In addition, source and level controls for the two Auxiliary Outputs may also be made visible on the **Overview** page (below the highest-numbered channel) by deselecting their default slave statuses. This is done by setting the **Slave** switches under the **Input Routing** and **Output** tabs on their individual channel pages to **No**. See page 26 for full details of the Auxiliary Outputs.

Audio pages - Channels

The page is divided into five tabs: **Input Routing**, **Room EQ**, **Speaker EQ**, **Output** and **Limiters**. You can open or close any of the tabs by clicking on the tab name bar. The page always opens with the **Input Routing** and **Output** tabs already open, as these contain the controls most often required.

The amplifier functions under browser control are summarised in the enhanced block diagram located at the bottom of this page.

Input Routing tab



- **Rear Panel** – the default position for this switch is **Yes**. In this setting, the other controls in the tab are greyed out and input routing for the amplifier channel (or pair of channels) will be determined by the settings on the **INPUT ROUTING** rear panel DIP switches (see “Connections and Adjustments” on page 14). Moving the switch to **No** activates the on-screen controls:

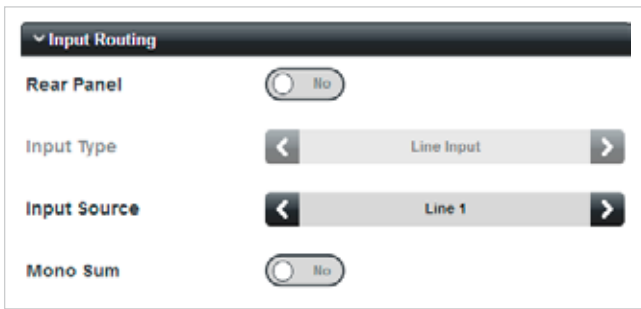

- **Input Source** – the default source is the input with the same number as the selected channel. Click the < and > buttons to select an alternative input. The number of inputs available will be 2, 4, or 8, depending on the amplifier model, and every input is available to every channel without restriction. Clicking > when the highest-numbered input is showing selects **Off**, which removes all input sources from the currently-selected channel. Once enabled, this control will also be displayed on the **Overview** page.
- **Mono Sum** – the default setting is **No**. Selecting **Yes** will feed a mono sum of two inputs to the selected channel, and the labelling of the **Input Source** switch changes to reflect this:

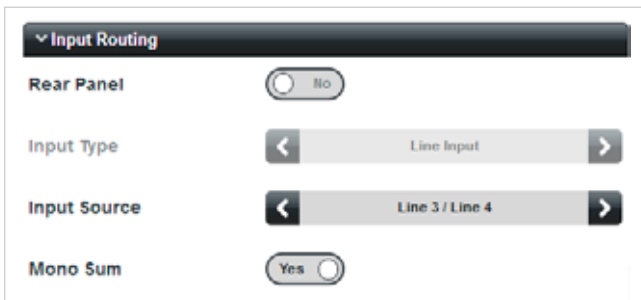

The two inputs will always be an adjacent odd/even pair, i.e., Inputs 1 & 2, 3 & 4, 5 & 6, or 7 & 8. The derived mono sum only applies to the currently-selected amplifier channel; all other channels retain the full range of inputs, including the individual odd and even inputs forming the mono sum.

- **Input Type** – this control is reserved for future development.

Room EQ tab

The **Room EQ** tab provides a flexible equaliser allowing the installer to optimise the amplifier to the room acoustics. The EQ has “basic” and “advanced” modes.

The EQ section is placed in circuit and the controls made visible by setting the **Enabled** switch to **Yes**. With **Advanced mode** set to **Off**, the basic controls are displayed:



In Basic mode, simple **Bass** and **Treble** shelving filters are provided. Click the + and – buttons to adjust the EQ. The controls have a range of +/-12 dB at frequencies of 10 kHz and 50 Hz respectively.

Setting **Advanced mode** to **On** makes additional controls visible:

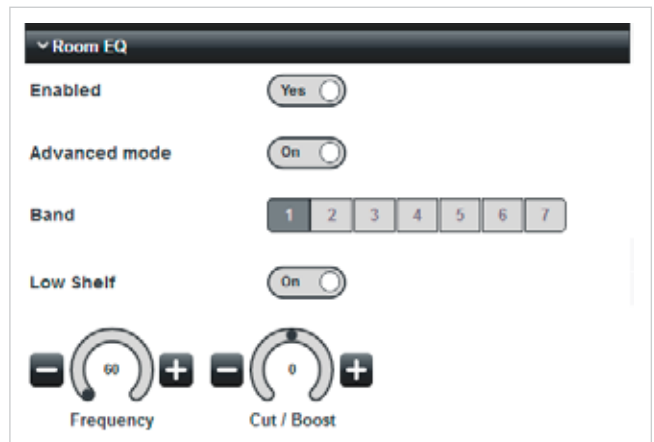

The Room EQ is now reconfigured as a seven band parametric equaliser, with peak/shelf switching on the highest and lowest bands. The **Band** buttons assign the rotary controls to each frequency band in turn: all bands have the same frequency range of 20 Hz to 20 kHz, adjusted by the **Frequency** control. However the seven default centre frequencies are 60 Hz, 250 Hz, 1 kHz, 2 kHz, 4 kHz, 8 kHz and 16 kHz, which will be suitable for most installations. The **Cut / Boost** control has a range of +/-12 dB.

In Bands 2 to 6, and also Bands 1 and 7 when **Low Shelf** (Band 1) or **High Shelf** (Band 7) is set to **off**, a **Q** control is added:

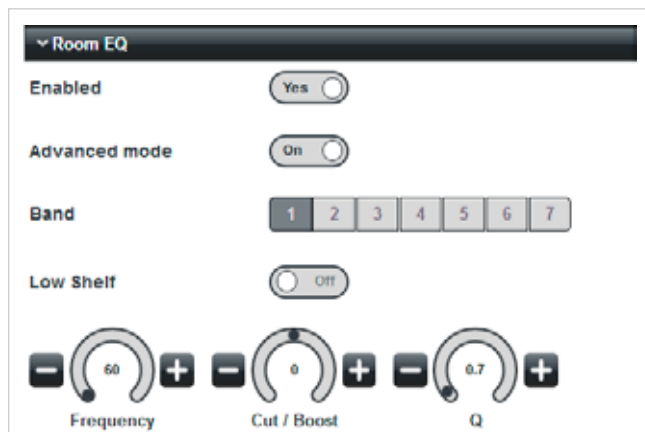

The **Q** control adjusts the bandwidth of the peaking filter over a range of 0.1 (broad) to 20 (narrow), with a default value of 0.7.

Speaker EQ tab

The **Speaker EQ** tab has controls for the steep, loudspeaker protection high-pass filter, and when enabled, a further five-band parametric equaliser, which can be used to accurately tailor the amplifier's frequency response to match that specified by speaker manufacturers.

High-pass filter:

The filter can also be switched in or out of circuit from the rear panel with the **HIGH PASS FILTER** DIP switches. These switches themselves may be enabled or disabled with the **Rear-panel** switch: the default setting is **Yes**, which enables the DIP switches.

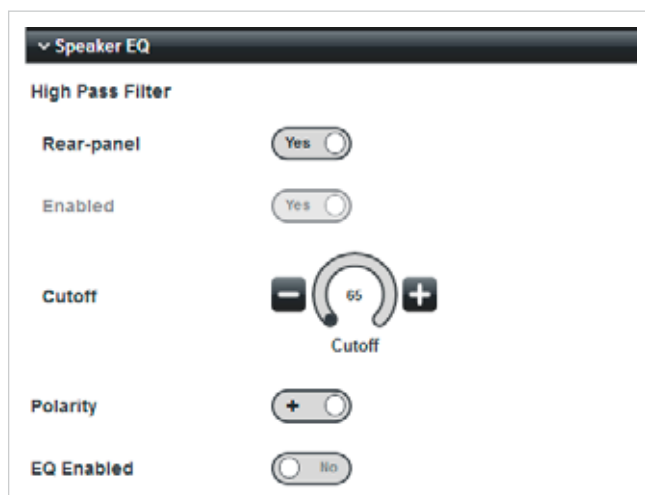

Setting **Rear-panel** to **No** disables the DIP switches and control of the high-pass filter is now only from the browser. However, the filter itself may still be taken out of circuit altogether by setting the **Enabled** switch to **No**. This restores the amplifier channel's full frequency response.

The high-pass filter is a variable-frequency, third-order type (slope 18 dB/oct), and has a frequency range of 20 Hz to 20 kHz, adjusted with the **Cutoff** control: use the **+** and **-** buttons to alter the value.

The filter should be adjusted to reject low frequencies, to suit both the speakers and the application. The default frequency is 65 Hz, which should be satisfactory for many models of loudspeaker. When adjusting, bear in mind that the higher the frequency setting, the less likely it is that the system will suffer from saturation problems.

The (minimum) 20 Hz setting should only be used when the speaker manufacturer explicitly states that they will operate correctly at such low frequencies.

Some guidance on selecting a filter frequency follows:

- **For speech-only** – Settings somewhere between 100 Hz (12 o'clock) and 200 Hz are appropriate. Start with the filter set to 100 Hz and turn the control clockwise whilst listening to speech through the system until you can hear a loss of bass in the voice. Few voices contain any useful signal below 200 Hz, so in many cases the filter can be set to 200 Hz without any real loss of quality. Often a setting this high will actually enhance the clarity of the speech, reduce microphone handling noise and reduce breath blasts.
- **For music systems** – The optimum filter setting will depend on the speakers and their transformers. It should be recognised that many 100 V line speakers have inferior LF performance compared to low impedance speakers. If the manufacturer recommends a minimum frequency of operation, set the filter to this. Otherwise, settings between 70 Hz and 100 Hz should be appropriate. Test the system at full volume with a variety of music containing high level, low bass notes and listen for any distortion. If the transformers saturate, distortion will be clearly audible. In this case, turn the control clockwise until it disappears.

It should be noted that the setting of the **Cutoff** control still defines the filter frequency if the **Rear-panel** switch is subsequently set to **Yes**: the value of 65 Hz above the rear panel DIP switches is only the default "out-of-the-box" value, and may be changed at will. When enabled, the rear panel **HIGH PASS FILTER** switches will switch the filter in or out at the frequency set for each channel by the **Cutoff** control.

The **Polarity** switch defaults to **+**. This will be the correct setting in the majority of installations, but under some circumstances, it may be necessary to introduce a phase reversal in a particular amplifier channel, in which case set the switch to **-**.

Speaker EQ:

The Speaker EQ section is made active with the **EQ Enabled** switch. Setting this switch to **Yes** makes additional controls visible. The EQ section has “basic and “advanced” modes, selected with the **Advanced mode** switch. With the switch set to **off**, two additional selector switches are displayed:

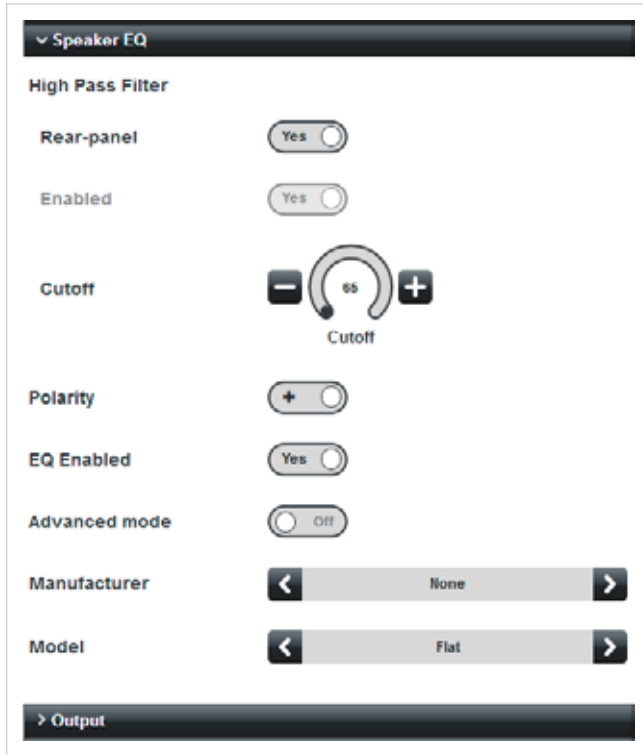

In this mode, it is possible to select a specific loudspeaker EQ preset from a set that has previously been installed. Installation of loudspeaker presets is via a firmware update.

The default **Manufacturer** is **None**, and the default **Model** is **Flat**, confirming that the Speaker EQ section will not affect the amplifier’s frequency response. Click on the < and > buttons of the **Manufacturer** and **Model** selectors to choose an alternative preset, if any are available. (Note that manufacturers’ presets will be automatically installed with firmware updates, as they become available.)

If a preset is not available, but the installer has the manufacturer’s recommended EQ settings for the loudspeaker being used, set the **Advanced mode** switch to **on**. This changes the control set as shown:

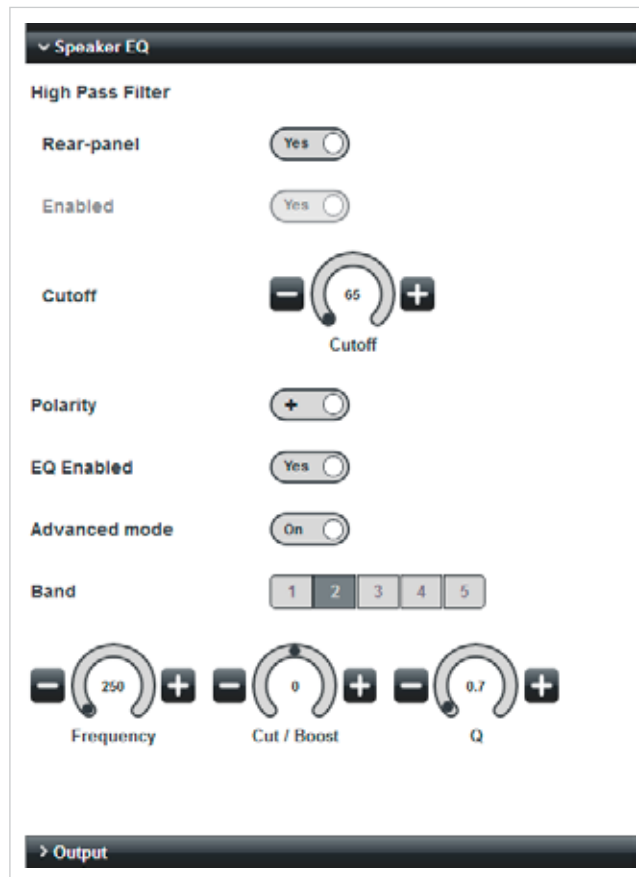

A five-band parametric equaliser is now available. The three rotary controls **Frequency**, **Cut / Boost** and **Q** adjust the frequency band selected by the **Band** buttons: use the + and - buttons to adjust the values. Default centre frequencies are 60 Hz, 250 Hz, 1 kHz, 4 kHz and 16 kHz, but may be adjusted with the **Frequency** control to any frequency between 20 Hz and 20 kHz in each band. The default **Q** setting is 0.7 in all five bands, but may be set to any value from 0.1 to 20. The range of the **Cut / Boost** control is +/-12 dB.

Use the controls to set the EQ curve according to the manufacturer’s data, which will usually be in the form of a number of dBs of cut or boost at specific frequencies. If a **Q** value is not provided, the default value of 0.7 may be taken as acceptable.

Output tab

The Output tab provides controls for the amplifier's output stage.

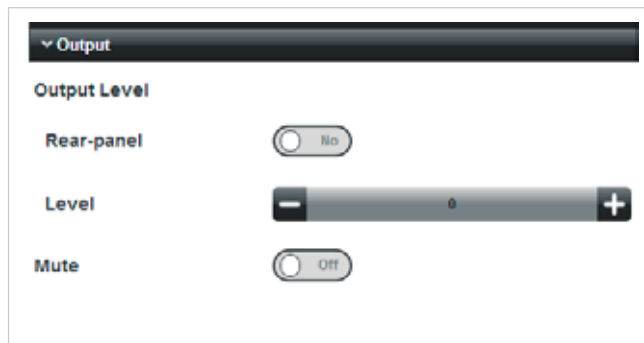

Output level:

- The **Rear-panel** switch has a default setting of **Yes**: in this position, the channel's output level is determined by the rear panel **LEVEL** preset control (and also an RL-1 Series remote control plate if one is fitted); the on-screen **Level** slider (see below) is greyed-out. Setting **Rear-panel** to **No** disables both the **LEVEL** control and the **REMOTE LEVEL** port for the currently-selected channel, and enables the **Level** slider.
- When enabled, the **Level** slider becomes the master level control for the channel. Click the + and – buttons to adjust. At the minimum setting of -90, the amplifier will effectively be off. Once enabled, this control will also be displayed on the **Overview** page.
- **Mute** – set **Mute** to **On** to mute the channel's output. This switch is duplicated on the **Overview** page.

Line voltage:

- **Rear-panel** – this switch enables/disables the rear panel **70V / 100V** DIP switches. The default setting is **Yes**, in which position the rear panel switches are enabled. Setting it to **No** disables the rear panel switches and enables the on-screen **Voltage** switch (see below).
- **Voltage** – set to either **100** or **70** to match the voltage of the line loudspeakers connected.

Limiter tab

Each channel of the amplifier includes a DSP-implemented limiter preceding the output stage.



The limiter is a simple peak-detecting type. Limiting action commences when the signal level exceeds the setting of the **Threshold** control; click the + and – buttons to adjust. This has a range of 24 dB in 1 dB increments. Limiting action triggered by the signal level exceeding the threshold has finite attack and release times, which have been optimised for most normal types of programme material.

With most “normal” programme material, and assuming the output levels are adjusted intelligently, the limiter's **Threshold** setting may be left at the default setting of 0 dB. This may be reduced to a lower level if the installer/user has reason to feel that the system may be abused.

Audio pages – Auxiliary Outputs

Each of the amplifier's two auxiliary line outputs have very similar facilities to the main channels. For many applications they can be used as two additional, fully-functional channels by connecting external power amplifiers.

The **Audio** pages for the two auxiliary outputs are selected from the **Audio** submenu in the same way as the main channels.

Input Routing tab



- **Slave** – the default position for this switch is **Yes**. With this setting, the source for the Auxiliary Output is “slaved” to that selected for one of the main amplifier channels. The channel is selected by the **Master** selector below. The signal source will in turn be determined by that channel's own Input Routing settings, either via the rear panel **INPUT ROUTING** DIP switches or the channel's **Audio** browser page (Input Routing tab). Note that setting **Slave** to **Yes** also adds additional controls to the **Output** tab (see “Output tab” on page 25).
- **Master** – click on the < and > buttons to select the channel that the Auxiliary Output's source is to be slaved to.

Setting **Slave** to **No** reveals two further controls:

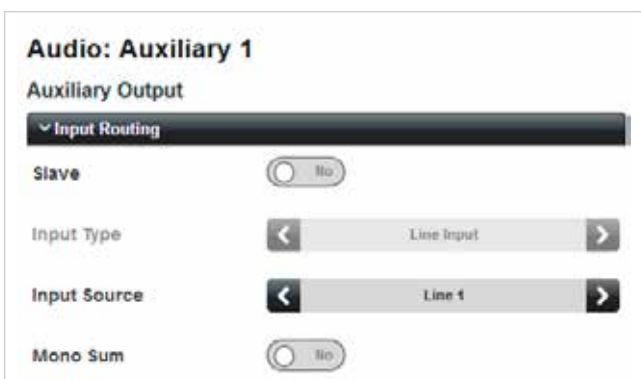

- **Input Source** – the default source is Input 1 for Auxiliary 1 and Input 2 for Auxiliary 2. Click the < and > buttons to select an alternative input. Every input is available to either Auxiliary Output. Clicking > when the highest-numbered input is showing selects **off**, which removes all input sources from the auxiliary channel.

Once enabled, this control will also be displayed on the **Overview** page.

- **Mono Sum** – the default setting is **No**. Selecting **Yes** will feed a mono sum of two inputs to the selected Auxiliary Output, and the labelling of the **Input Source** switch changes to reflect this, as with the corresponding switch in the main channels. Selecting a mono sum of two inputs as the source for one Auxiliary does not affect the choice available to the other: if Aux 1 is selected to receive a mono sum of Inputs 1 and 2, both Inputs 1 and 2 are independently available to Aux 2.
- **Input Type** – this control is greyed-out unless the optional CDI-CV8 Dante™ input card is fitted.

Room EQ tab

The controls on this tab are identical to those on the Room EQ tab of the main amplifier channels. See “Room EQ tab” on page 22.

Filter tab

The auxiliary channels are provided with an additional, flexible filter section, which is switched out of circuit by default (**Filter Type** set to **None**):



- **Filter Type** – **Low Pass** and **High Pass** options are available. Selecting either makes further controls visible:

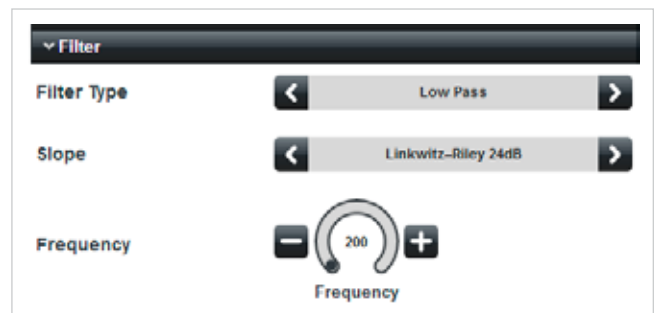

- **Slope** – a choice of three common filter types is offered: **Bessel**, **Butterworth** and **Linkwitz-Riley**. Bessel and Butterworth filters offer a choice of 12, 18 or 24 dB/octave slopes; Linkwitz-Riley filters offer 12, 24, 36 or 48 dB/octave. Loudspeaker manufacturers will generally advise on the most appropriate type of filter for a particular speaker system in their own technical documentation.
- **Frequency** – sets the cutoff frequency of the filter: the range is 20 Hz to 20 kHz, with a default frequency of 200 Hz.

Speaker EQ tab

The **Speaker EQ** tab has controls for the steep, loudspeaker protection high-pass filter, and when enabled, a further five-band parametric equaliser, which can be used to accurately tailor the amplifier's frequency response to match that specified by speaker manufacturers.

High-pass filter:

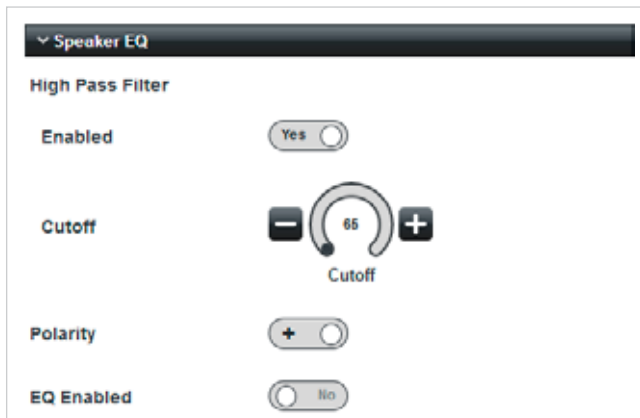

The high-pass filter is out of circuit by default, with **Enabled** set to **No**. This ensures the auxiliary channel has its full frequency response. The filter may be inserted by setting **Enabled** to **Yes**.

The filter has the same characteristics as the high-pass filter in the main amplifier channels, and the **Cutoff** and **Polarity** controls have the same functions. The default filter frequency is 65 Hz. Note that unlike the main channels, the Auxiliary Outputs do not have rear panel DIP switches for enabling/disabling the filter.

Speaker EQ:

The Speaker EQ section is made active with the **EQ Enabled** switch. The characteristics and controls for the Speaker EQ section are identical to those found in the main amplifier channels. See "Speaker EQ:" on page 24.

Output tab

The Output tab allows control of the Auxiliary Output's level. The controls available on the tab are affected by the setting of the **Slave** switch on the Input Routing tab. With **Slave** set to **No**, so that the Auxiliary Output can be sourced independently from any of the Line Inputs, the tab appears as shown in the next column.



- The **Output Level** slider is the master level control for the Auxiliary Output. Click the + and – buttons to adjust. At the minimum setting of -90, the output will effectively be off.
- **Mute** – set **Mute** to **On** to mute the Auxiliary Output.

Once enabled, the **Output Level** and **Mute** controls will also be visible on the **Overview** page. Control will also be displayed on the **Overview** page.

If the **Slave** switch on the Input Routing tab is set to **Yes**, so that the source for the Auxiliary Output is that selected for an amplifier channel (see "Input Routing tab" on page 26), two additional switches are available on the Output tab:

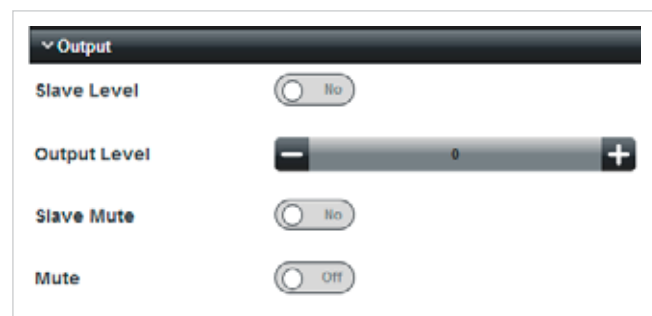

- **Slave Level** – this switch defaults to **Yes**: the **Output Level** control is greyed-out. With this setting, the level of the Auxiliary Output is slaved to the output level control of the channel which is its source. This will either be the source channel's rear panel **LEVEL** preset control, or the **Level** control on the Output tab of the Audio browser page for the source channel, depending on the position of the **Rear-panel** switch on that tab. If **Slave Level** is set to **No**, the level of the Auxiliary Output can be set with the **Output Level** control as described above.
- **Slave Mute** – this switch has the same logical function as **Slave Level**, but applies to how the Auxiliary Output is muted when it is slaved to an amplifier channel. The default is **Yes**: the adjacent **Mute** switch is greyed-out and the Auxiliary Output will be muted when the **Mute** switch on the Output tab of the source channel's Audio browser page is set to **On**. When **Slave Mute** is set to **No**, the adjacent **Mute** switch is enabled and the Auxiliary Output may be muted independently of the source channel.

Limiter tab

Each Auxiliary Output is provided with a limiter which has the same characteristics and operating controls as the limiter in the main amplifier channels. See "Limiter tab" on page 25 for details.

Submenu: DSP Configuration

The DSP sections of CVA Digital amplifiers may be easily configured in a variety of ways to permit the amplifiers to work conveniently in stereo modes, and also to create active crossovers for bi-amping two-way loudspeaker systems.

"Out-of-the-box", the amplifiers are configured with multiple, independent mono channels, the number depending on the model. Selecting the various input routing options already described in this Installation Guide, either by the rear panel DIP switches or the browser pages, does not alter this fundamental multi-channel architecture.

Alternative configurations may be implemented using the **DSP Configuration** browser page. This is accessed from the main menu, by selecting **Config**, then **DSP Configuration**. The **DSP Configuration** page varies with model:

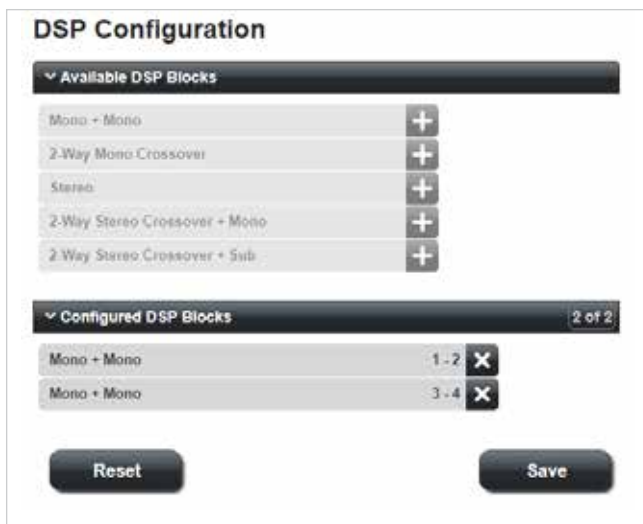

Model: CVA2500



Model: CVA4250

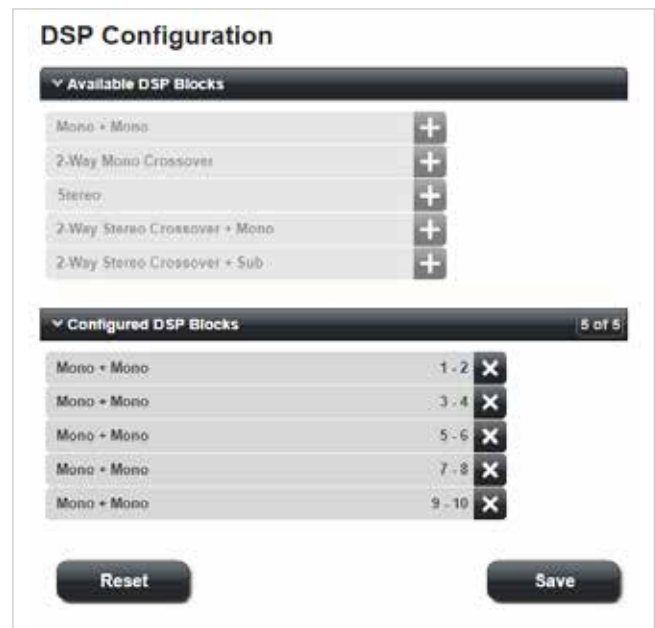

Model: CVA8125

DSP Configuration employs the principle of "DSP Blocks", which always use odd/even pairs of amplifier channels. For the purposes of reallocating DSP blocks, it should be noted that the two Auxiliary Outputs are treated simply as additional amplifier channels (although they lack a power output stage).

The **DSP Configuration** page comprises two tabs, **Available DSP Blocks** and **Configured DSP Blocks**. The initial DSP allocation is with all the available DSP blocks configured as **Mono + Mono**, and the **Available DSP Blocks** are all greyed-out, confirming that all amplifier channels (including the Auxiliary Outputs) are already configured in some way. Note that the numbering of the **Configured DSP Blocks** allows for the Auxiliary Outputs, which are always the highest-numbered pair: 3-4 in the CVA2500, 5-6 in the CVA4250, and 9-10 in the CVA8125. The lower numbers are those of the main channels.

The current DSP allocation may be cleared by clicking on the **x** at the right-hand end of the **Configured DSP Blocks**. Note that clicking the **x** on any block appears to remove the highest-numbered block as the higher-numbered blocks shuffle upwards as the block is removed. As the default **Mono + Mono** blocks are cleared, blocks in the **Available DSP Blocks** tab become available: when they have all been removed, the page looks like this:

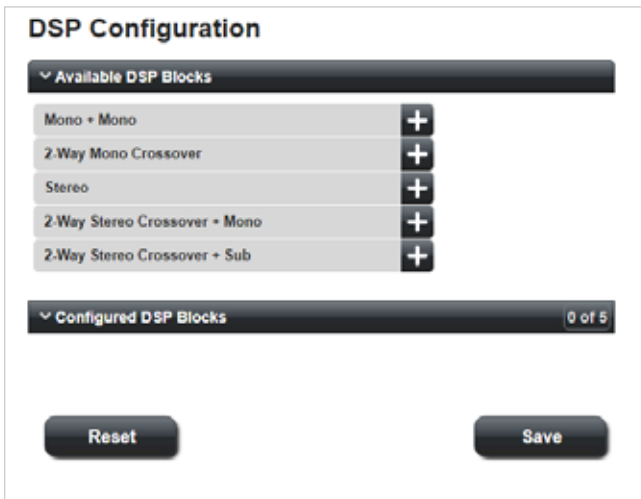

Stereo configurations

To create a pair of amplifier channels that will be controllable from a single page – as would be appropriate for a stereo input source, click the + button to the right of the **stereo** block in **Available DSP Blocks**.

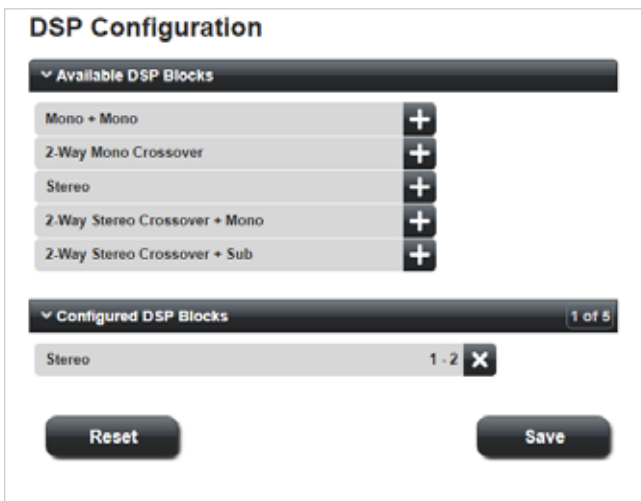

DSP blocks will be added to the **Configured DSP Blocks** tab in ascending numerical order. The above screenshot indicates that Channels 1 and 2 will form a stereo pair. If this is the only stereo block required and the other amplifier channels are to remain mono, click the + to the right of the **Mono + Mono** block as many times as necessary to fill the available DSP slots (the number varies with model):



In most installations, it will be largely irrelevant which channels are allocated for stereo use, but if it is necessary to specify a particular pair of channels (which must always be an adjacent odd/even pair), then **Mono + Mono** DSP blocks must be allocated to lower-numbered channels first. For example if it was wished to use Channels 5 and 6 as the stereo pair, then two **Mono + Mono** blocks would be assigned first (to Channels 1 and 2, then 3 and 4), then the stereo block, followed by **Mono + Mono** blocks to higher-numbered channels. The allocation would then look like this in the case of the CVA8125:



Stereo channels

When a stereo DSP block has been assigned to a pair of channels, the Audio menu changes to reflect this. The example shows the menu for a CVA8125 with a stereo block allocated to Channels 1 and 2:



Note that the revised status of Channels 1 and 2 – **Stereo** - is confirmed at the top of the **Audio** page. All the controls on all tabs now affect both Channel 1 and Channel 2 simultaneously:



Compare this with the corresponding page for a mono channel (see page 19). The only differences lie in the **Input Routing** tab: the **Input Source** selector now presents odd/even pairs of Line Inputs. Also note the **Mono Sum** switch is not present on stereo channels (as it would defeat the purpose of a stereo channel):



When a stereo DSP block has been allocated to a pair of channels, this is also reflected in the **Input Routing** tab of the Auxiliary Outputs:



Auxiliary Outputs are by default mono. When one is slaved to a stereo pair of channels, its source becomes a mono sum of the signals in the two channels. Alternative, mono amplifier channels will be available as sources via the **Master** selector as single channels in the normal way. Source selection for Auxiliary Outputs when they are not in Slave mode is unchanged: any Line Input (or **off**) may be selected.

Stereo Auxiliary Outputs

A stereo DSP block may be allocated to the highest-numbered pair of channels, which will convert the two Auxiliary Outputs into a stereo pair. Such an allocation may be made whether or not the amplifier has also been configured with any stereo main channels.

In an identical manner to the browser pages for the main amplifier channels, the source selection options on the **Input Routing** tab change to reflect the stereo mode now adopted by the Auxiliary Outputs:



Slave = No



Slave = Yes

The **Mono Sum** switch is also removed.

If there are one or more stereo main channels, the source selection for Auxiliary Outputs in stereo mode also will correctly follow the mono or stereo status of the source channels in Slave mode.

Using Crossovers

DSP blocks are available to create channels suitable for use with bi-amped, two-way loudspeaker systems. Such systems require the use of a frequency crossover to separate low and high frequencies, and two separate amplifier channels, one for LF, the other for HF.

The DSP blocks can be transferred from the **Available DSP Blocks** tab to the **Configured DSP Blocks** tab in exactly the same way as Stereo blocks. Three crossover options are available:

- **2 Way Mono Crossover:** allocates two channels (LF & HF)
- **2 Way Stereo Crossover + Mono:** allocates four channels (HF(L), HF(R), mono LF, plus spare mono channel)
- **2 Way Stereo Crossover + Sub:** allocates four channels (HF(L), HF(R), 2 x mono LF)

All three options are realisable in all CVA Digital models. In the case of the two channel CVA2500, implementing either of the stereo crossovers will require the use of both main amplifier channels (used for HF) and both Auxiliary Outputs (used for LF), and thus additional external amplification will be required for the low frequencies.

All crossover types are configured from the DSP Configuration page and follow a similar method to stereo channel configuration.

2-Way Mono Crossover

To create a 2-way mono crossover, remove as many DSP Blocks as necessary from the Configured DSP Blocks tab (the number will depend on which pair of channels it is desired to use for the crossover), and add a 2-Way Mono Crossover DSP Block from the **Available DSP Blocks** tab. The example below, from a CVA8125, shows that Channels 3 and 4 have been configured as the 2-Way Mono Crossover, while the other four pairs of channels (including the Auxiliary Outputs) remain as mono.

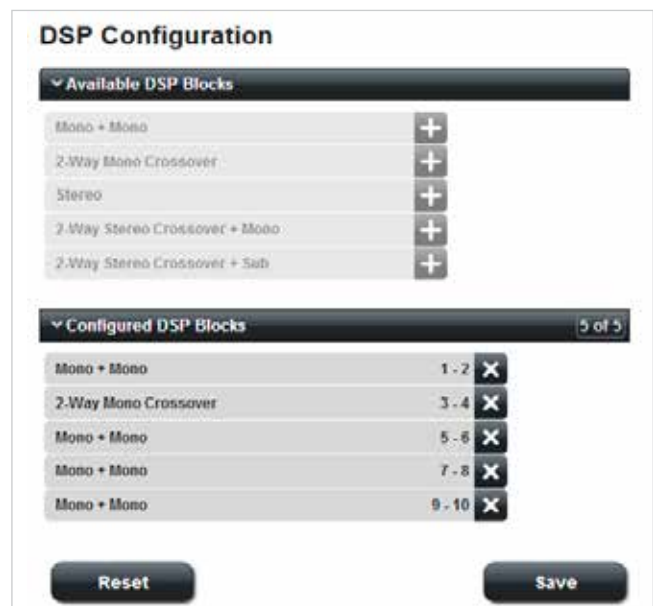

The Audio page for Channels 3 and 4 are altered to accommodate the additional controls required for the crossover:

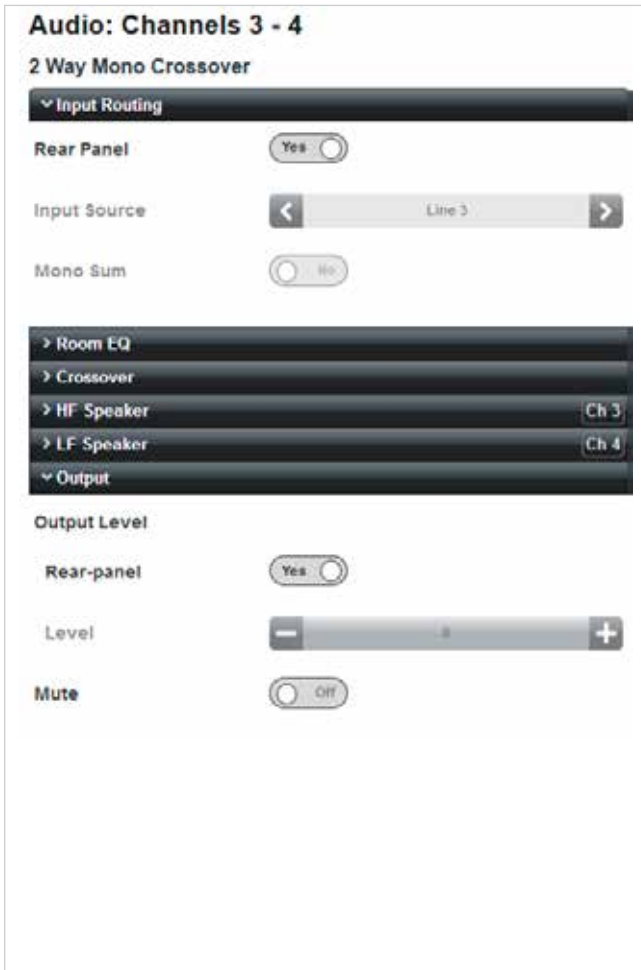

Note that the revised status of Channels 3 and 4 – **2 Way Mono Crossover** - is confirmed at the top of the **Audio** page. The page is now divided into seven tabs: **Input Routing**, **Room EQ**, **Crossover**, **HF Speaker**, **LF Speaker**, **Output** and **Limiter**. The facilities on the **Input Routing**, **Room EQ**, **Output** and **Limiter** tabs are identical to those on a standard mono or stereo channel; the **Speaker EQ** tab is replaced by three tabs related to bi-amped operation.

Input Routing tab:

The source for the channel pair will be determined either by the rear panel DIP switches or Input Source selector on the Input Routing tab in the normal way. Note that the channel pair uses a mono source, either a single Line Input or a mono sum of two Line Inputs if, e.g., a stereo source is connected.

Crossover tab:

The frequency division crossover is controlled by the **Crossover** tab, which has basic and advanced modes in a similar manner to the Room EQ section:

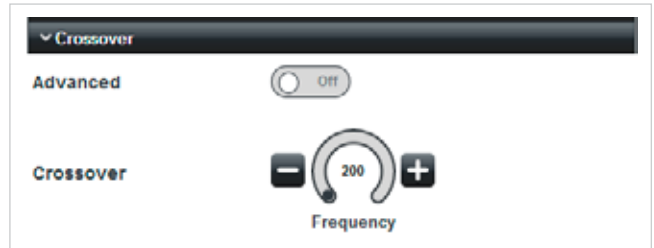

With **Advanced** set to **Off**, a default crossover is implemented, adjusted by the Frequency control: the crossover type is a Linkwitz-Riley filter with a slope of 24 dB/octave. The range of adjustment is the full audio range of 20 Hz to 20 kHz. Signal content above the crossover frequency will be routed to the **HF Speaker** channel (in this example, Channel 3) and content below the crossover frequency to the **LF Speaker** channel (in this example, Channel 4).

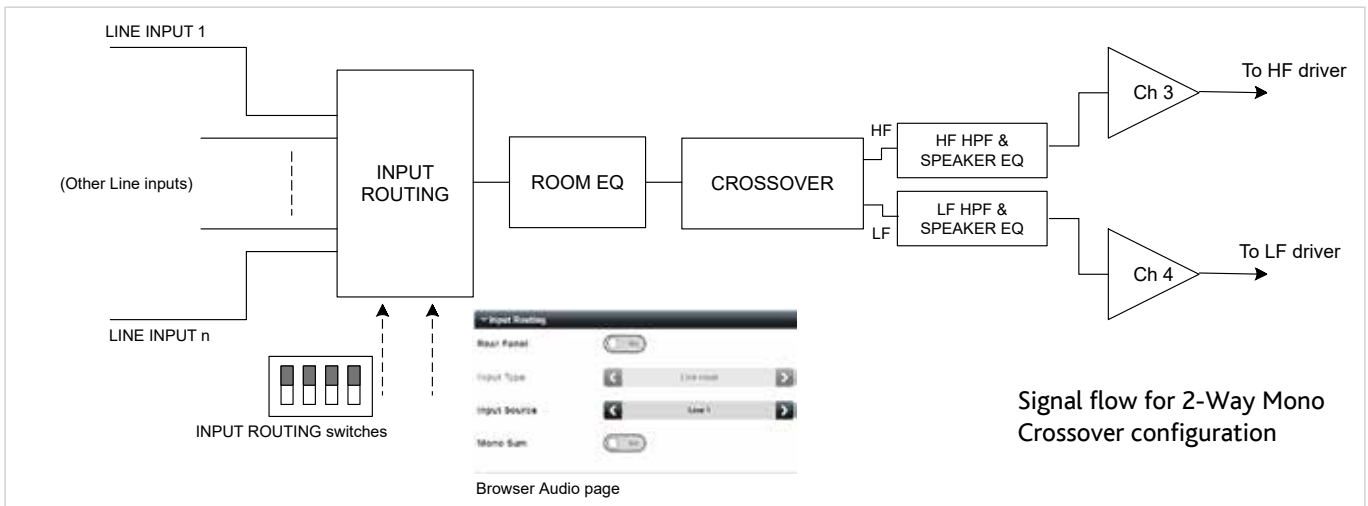

Signal flow for 2-Way Mono Crossover configuration

Setting Advanced to On reveals further controls:



- **Slope** - gives a much wider choice of crossover types: **Bessel**, **Butterworth** and other **Linkwitz-Riley** filter types are available. The Bessel and Butterworth filters offer a choice of 12, 18 or 24 dB/octave slopes; Linkwitz-Riley filters offer 12, 24 (as the default), 36 or 48 dB/octave. Loudspeaker manufacturers will generally advise on the most appropriate type of filter for a particular speaker system in their own technical documentation.
- **Overlap** – setting this switch to **On** replaces the single **Frequency** control with separate controls for the low-pass and high-pass filter sections of the crossover:

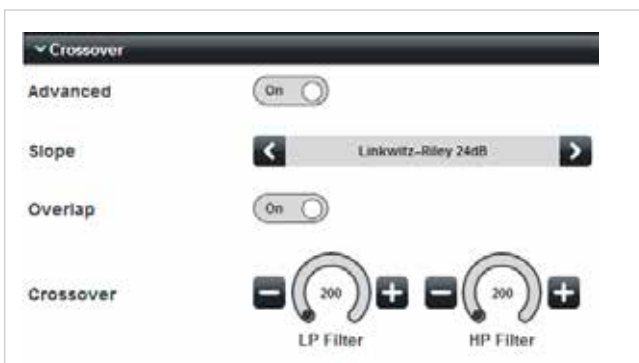

This permits a greater degree of control in tailoring the response of the crossover. Both filter controls have the full audio range of 20 Hz to 20 kHz, and thus the turnover frequencies of each filter section may be adjusted to be as close together or as far apart as wished, the variation determining the flatness of overall frequency response in the crossover region. Again, loudspeaker manufacturers will generally offer recommendations for particular speaker types.

HF Speaker and LF Speaker tabs:

The facilities on the **HF Speaker** and **LF Speaker** tabs are identical. In the example shown, Channel 3 is used for the HF loudspeaker driver and Channel 4 for the LF driver, or subwoofer, depending on the type of loudspeaker system being used.

The tabs are very similar to the **Speaker EQ** tab on the **Audio** page of mono amplifier channels. There are controls for the high-pass protection filter, and optionally, loudspeaker EQ, both in the form of recallable fixed presets, or, in **Advanced Mode**, a five-band parametric equaliser. See “Speaker EQ:” on page 24 for full details.

One additional control is available to channel pairs configured for crossover operation: **Trim**. This permits fine adjustment of the channel level for each loudspeaker driver individually; the control has a range of 12 dB, with 0 representing full level.

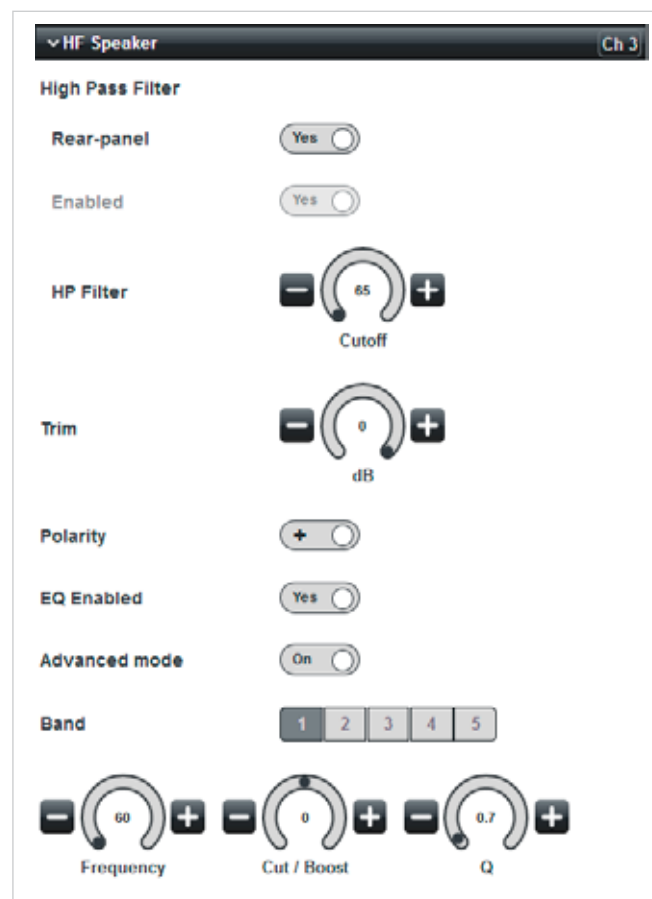

HF Speaker
Ch 3

High Pass Filter

Rear-panel Yes

Enabled Yes

HP Filter Cutoff

Trim dB

Polarity +

EQ Enabled Yes

Advanced mode Off

Manufacturer

Model

HF Speaker
Ch 3

High Pass Filter

Rear-panel Yes

Enabled Yes

HP Filter Cutoff

Trim dB

Polarity +

EQ Enabled Yes

Advanced mode On

Band 1 2 3 4 5

Frequency
 Cut / Boost
 Q

2-Way Stereo Crossover + Mono

This configuration is particularly suitable where stereo reproduction is required, and the speaker system includes a separate subwoofer.

The crossover configuration is created in same manner as the 2-Way Mono Crossover. The example below is using a CVA8125, and shows that Channels 1 to 4 have been allocated in the crossover configuration, while the other three pairs of channels (including the Auxiliary Outputs) remain as mono.

DSP Configuration

Available DSP Blocks

| | |
|-------------------------------|---|
| Mono + Mono | + |
| 2-Way Mono Crossover | + |
| Stereo | + |
| 2-Way Stereo Crossover + Mono | + |
| 2-Way Stereo Crossover + Sub | + |

Configured DSP Blocks
5 of 5

| | | |
|-------------------------------|--------|---|
| 2-Way Stereo Crossover + Mono | 1 - 4 | X |
| Mono + Mono | 5 - 6 | X |
| Mono + Mono | 7 - 8 | X |
| Mono + Mono | 9 - 10 | X |

Reset
Save

This configuration actually only requires three amplifier channels to be configured for the crossover itself: the fourth channel remains mono and independent. It is included in the DSP block allocation, however, because DSP blocks can only be allocated in odd/even pairs. The result can be seen in the drop-down menu:

Audio

- Overview
- Channels 1 - 3
- Channel 4
- Channel 5
- Channel 6
- Channel 7
- Channel 8
- Auxiliary 1
- Auxiliary 2
- Monitoring
- Event Log
- Config
- Logout

Channels 1 to 3 now have a common **Audio** page: note that it is very similar in appearance to the **Audio** page for a 2-way mono crossover (see page 32).

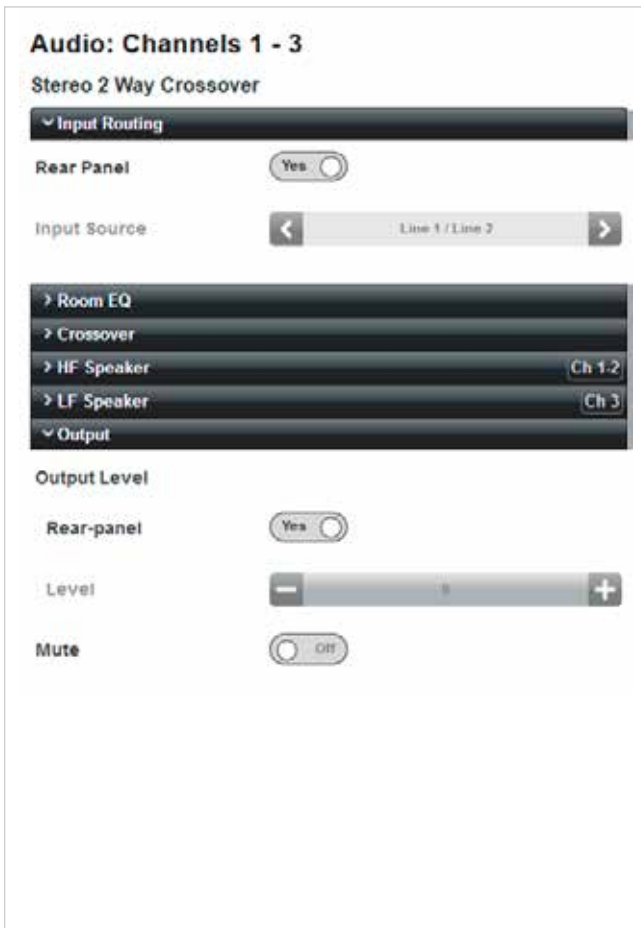

The status of the three channels is confirmed at the top of the page. The page has the same seven tabs as the 2-Way Mono Crossover **Audio** page. Note however, that the **HF Speaker** tab is now annotated **Ch 1-2** and the **LF Speaker** tab **Ch 3**, indicating that (in this example), these are how the channels are deployed.

Because low frequencies are substantially non-directional, it is normal to sum the LF components of a stereo signal into a single mono signal, which is then used to drive a separate mono subwoofer. Thus two channels carry the HF components of the left and right input signals, and a third channel carries the LF components of both left and right, summed together. The fourth channel generated by the DSP allocation remains completely independent and may be used for any purpose.

Input Routing tab:

The three channels comprising the stereo crossover will have two inputs (L and R) and hence the **Input Source** selector will indicate pairs of Line Inputs. Note the **Mono Sum** switch is no longer available:

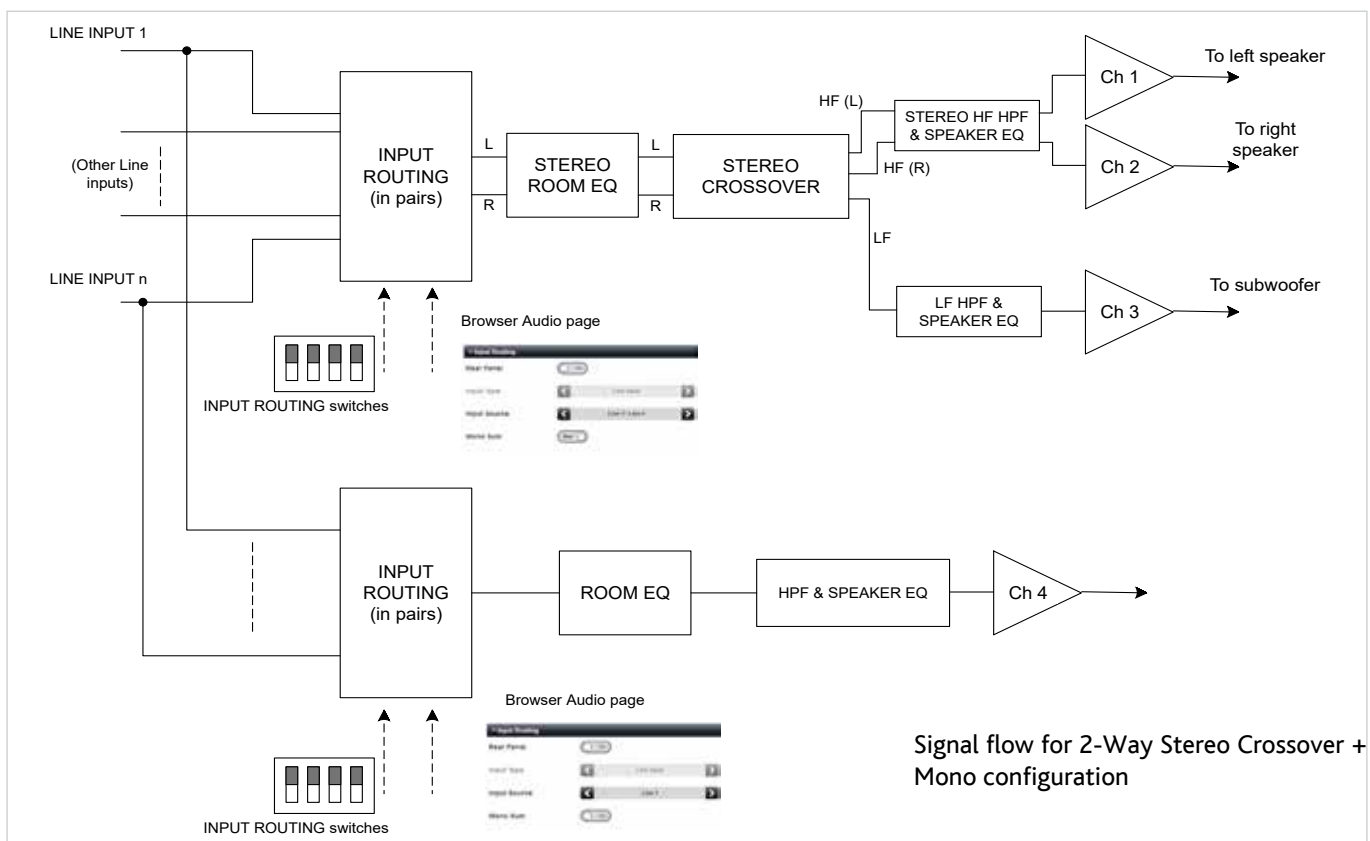

Other tabs:

The **Crossover**, **HF Speaker** and **LF Speaker** tabs are identical in appearance and facilities to the corresponding tabs on the **Audio** page for a 2-Way Mono Crossover (see page 32). The **Room EQ**, **Output** and **Limiters** tabs are identical in appearance and facilities to the corresponding tabs on the **Audio** page for a standard mono or stereo channel.

In a stereo crossover configuration, all the controls affect both the L and R signals making up the stereo input, in the same way as for a stereo pair of channels.

2-Way Stereo Crossover + Sub

This configuration is suitable where stereo reproduction is required, either using a pair of 2-way bi-amped speakers with separate LF and HF drivers, or a pair of full range speakers with two subwoofers.

The crossover configuration is created in same manner as the 2-Way Mono Crossover. The example below is using a CVA8125, and shows that Channels 5 to 8 have been allocated in the crossover configuration, while the other three pairs of channels (including the Auxiliary Outputs) remain as mono.



This configuration uses four amplifier channels for the crossover: like the 2-Way Stereo Crossover + Mono DSP block configuration, the two lower-numbered channels are used for stereo HF, and the other two carry the same (L+R) mono sum. The result can be seen in the drop-down menu:

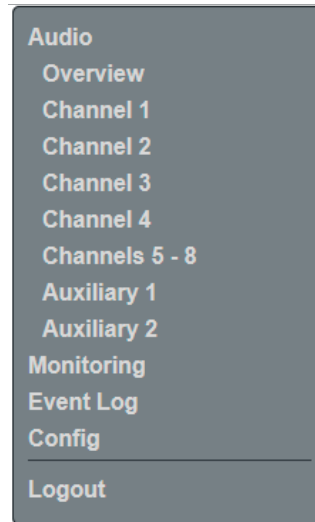

Channels 5 to 8 now share a common **Audio** page: note that the page is identical in appearance to the **Audio** page for the 2-Way Stereo Crossover DSP block configuration described on page 34:

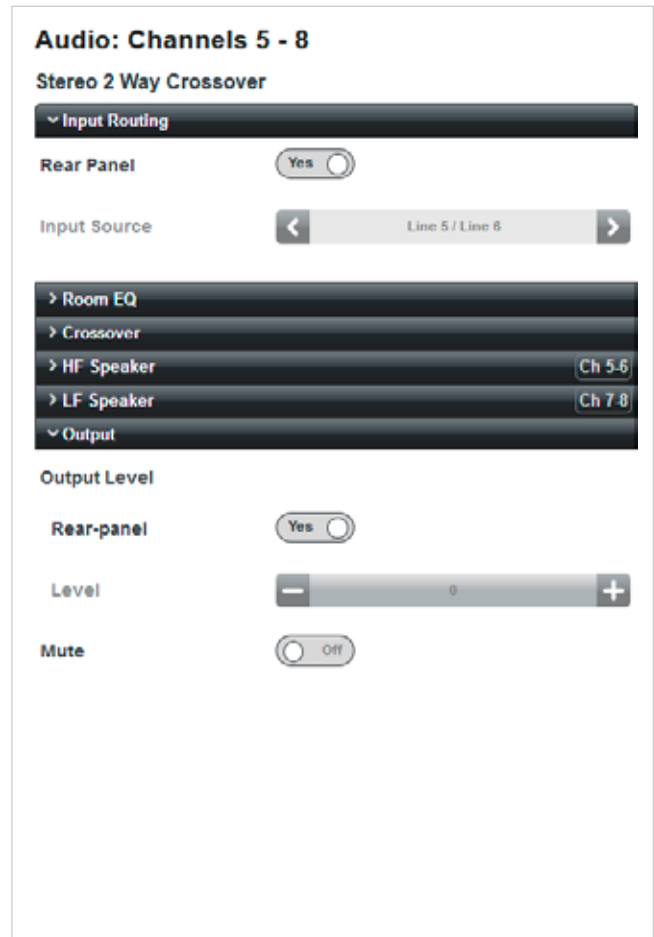

The status of the four channels is confirmed at the top of the page. Note that the **HF Speaker** tab is annotated **Ch 5-6** but the **LF Speaker** tab is now annotated **Ch 7-8**, indicating that (in this example) Channels 7 and 8 both now form part of the crossover.

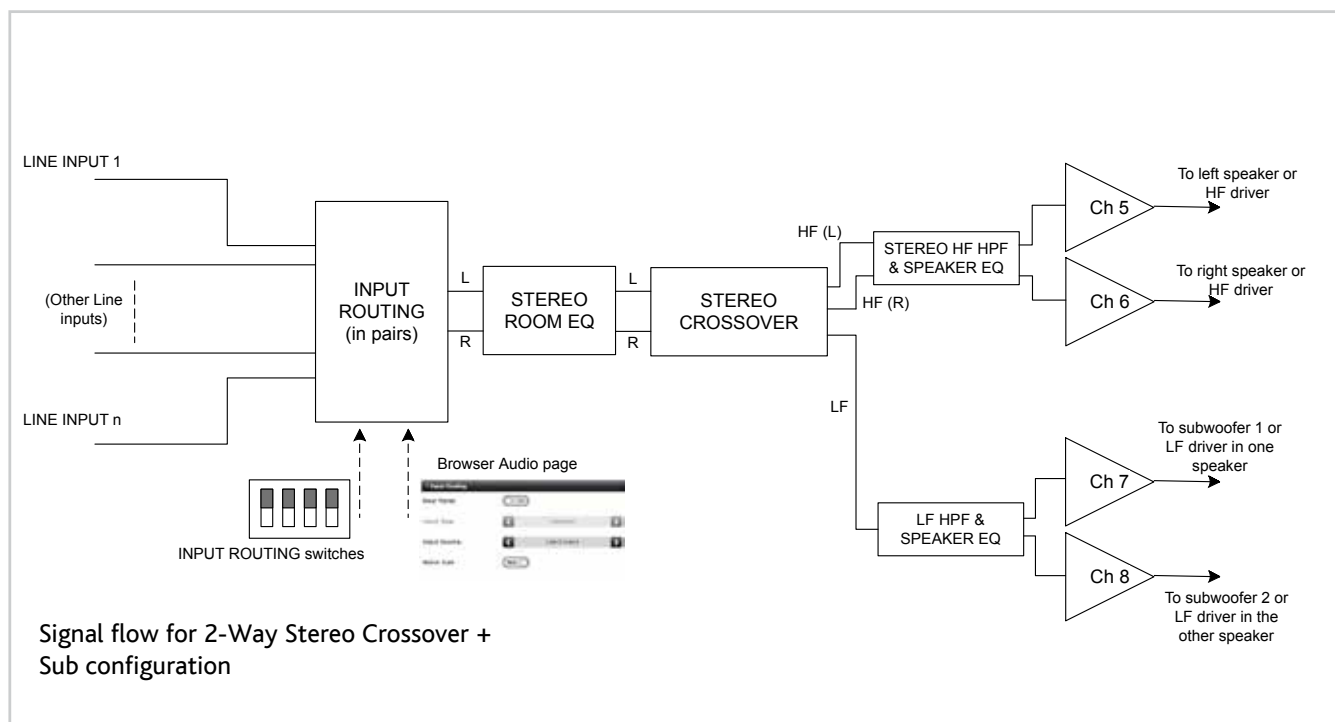

The LF components of the stereo signal are summed into a single mono signal, which is then routed to the two higher-numbered channels. The HF components of the left and right input signals are routed to the two lower-numbered channels, as in the 2-Way Stereo Crossover + Mono example on page 34.

The controls on the **Audio** page for this configuration of crossover are identical to those in the 2-Way Stereo Crossover + Mono configuration. As before, all the controls affect both the L and R signals making up the stereo input, in the same way as for a stereo pair of channels.

The significant difference from the previous example is that the fourth amplifier channel now carries the same LF mono sum signal as the third channel: Channels 7 and 8 in the example. This permits a pair of 2-way speakers to be bi-amped; their HF terminals should be connected to the outputs of Channels 5 and 6 (L and R respectively) and their LF terminals to the outputs of Channels 7 and 8. Note that the LF signal will be a mono sum of (L+R), not separate L and R signals, but this will generally not be of consequence due to the relative absence of low frequency localisation. Alternatively, this configuration is convenient for speaker systems which comprise a full range cabinet combined with a separate subwoofer (often the upper and lower components of a pole structure). Each of the two LF channels can now drive the two subwoofers independently.

Using the Auxiliary Outputs with Crossovers

Because the two Auxiliary Outputs are effectively fully functional “channels” without power output stages, there is no restriction on including them in a crossover configuration. Using the Auxiliary Outputs as one or two LF channels would have the advantages of freeing up main amplifier channels, and also of allowing the connection of external amplifiers with a higher power rating than is available from the CVA Digital amplifier, which may well be of benefit with high power music speaker systems, for example, those with active subwoofers.

When configuring DSP blocks for use with the Auxiliary Outputs, it must be remembered that the Auxiliary Outputs are always represented by the highest-numbered DSP block. In the example below, from a CVA8125, a 2-Way Stereo Crossover + Sub configuration has been allocated to Blocks 7-10:



This configuration is now displayed in the Audio submenu as shown below:

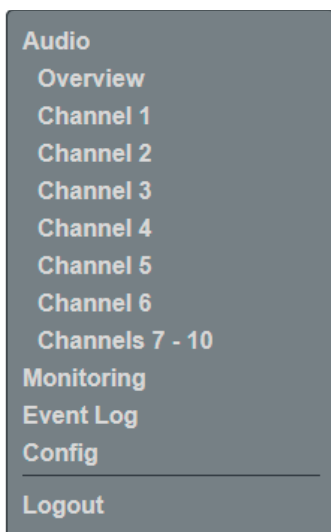

Note that the entries for the Auxiliary Outputs have been removed. The Audio Page for Channels 7-10 now looks like this:

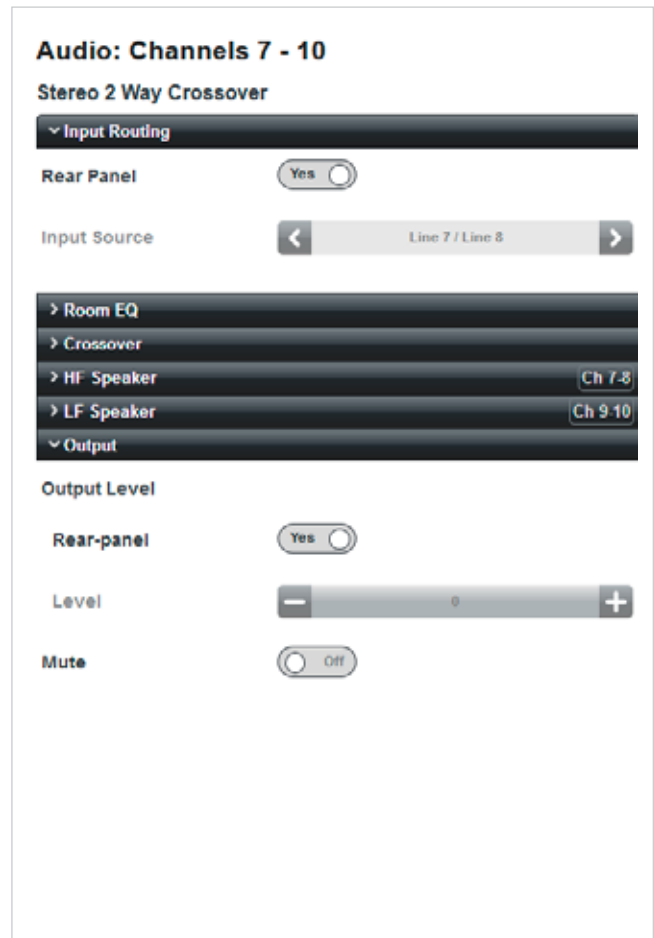

Note that the LF Speaker tab is now annotated ch 9-10, these are in fact the two Auxiliary Outputs. In all respects, the setting-up and adjustment of the crossover is identical to that described previously, the only difference being that the two mono LF (L+R) sums will now appear at line level at the Auxiliary Outputs.

Other Menus and Submenus

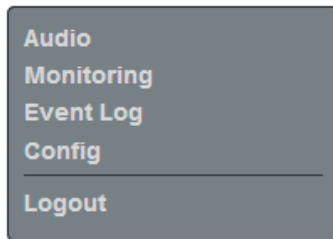

Monitoring

The Monitoring page provides information about the amplifier's current status. There are three tabs – **Status**, **Rear Panel Controls** and **Temperature**. Apart from the two **Channel** selectors on the **Status** and **Temperature** tabs, all the page features are passive indicators.

Note that the screenshots shown below are those of a CVA8125: other models in the range will have reduced sets of controls and displays to reflect the lower channel count.

Status tab

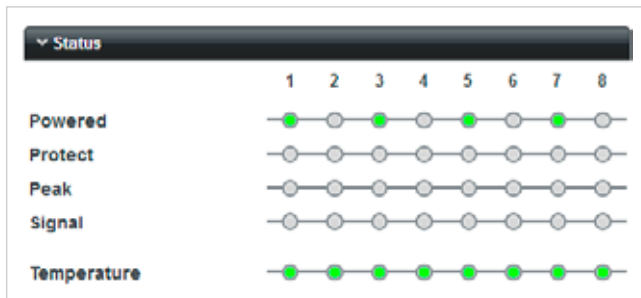

- **Powered**, **Protect**, **Peak** and **Signal** – these virtual LEDs (one per function per channel) are mimics of the LEDs on the front panel. See page 10 for a description of their functions.
- **Temperature** – these are tricolour virtual LEDs which give a “coarse” indication of the temperature of each channel's output stage:
 - Green: 65 °C
 - Amber: <75 °C
 - Red: ≥75 °C

Temperature is only monitored while the amplifier is operational, i.e., not in APD Mode.

Note that the exact temperature is displayed on the **Temperature** tab (see opposite).

Rear Panel Controls tab

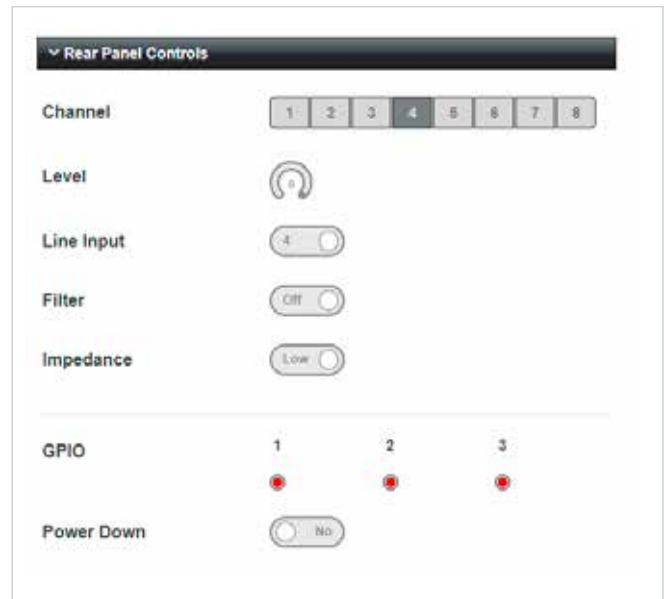

- **Channel** – select the channel whose rear panel control settings are to be displayed below.
- **Level** – a mimic of the rear panel **LEVEL** control, together with a numeric readout of the equivalent attenuation in dBs, relative to the maximum setting of 0 dB.
- **Line input** – shows the source input for the selected channel. The position of the switch itself mimics the physical position of the rear panel **INPUT ROUTING** DIP switch: left = DIP switch up, right = DIP switch down.
- **Filter** – mimics the setting of the rear panel **HIGH PASS FILTER** DIP switch for the selected channel.
- **Impedance** - mimics the setting of the rear panel **SPEAKER LOAD** DIP switch for the selected channel.
- **GPIO** – three bicolour virtual LEDs which indicate the logic state of the GPIO ports:
 - Red: high (~+10 V)
 - Green: low (< +0.5 V)
- **Power down** – mimics the state of the **REMOTE PWR DOWN** connector: **No** = amplifier is active, **Yes** = amplifier is in APD Mode.

Temperature tab

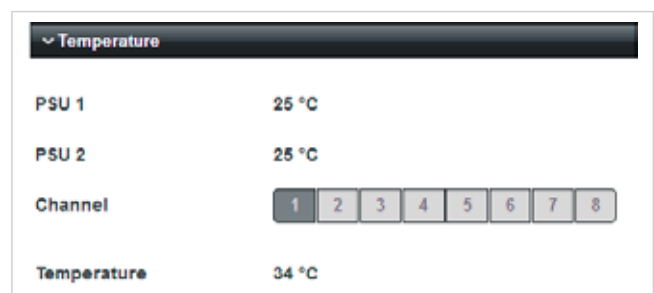

This tab reports the temperatures measured at various points in the amplifier.

- **PSU1** and **PSU2** – display the temperatures measured within the two power supplies (for odd- and even-numbered channels).
- **Channel** – select the channel whose temperature to be displayed below.
- **Temperature** – displays the temperature measured within the power output stage of each channel, provided the amplifier is not in APD Mode.

Event Log

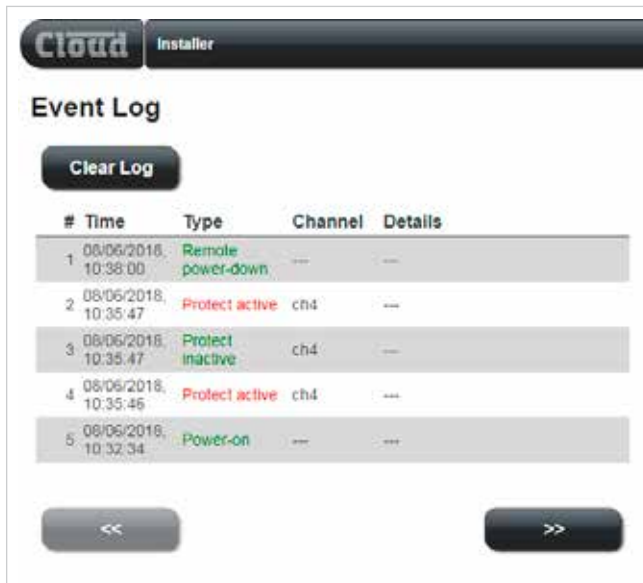

The amplifier can maintain a log of critical events. This can be viewed to check whether amplifier fault conditions have given rise to operational problems.

The event types which may be recorded are listed below. Each event type may be individually enabled for logging on the **Logging** page (see “Submenu: Logging” on page 45).

- Power-on*
- Power-off*
- Over-temperature
- Return to normal temperature
- Protection Mode entered
- Protection Mode exited
- Remote Power Down applied
- Remote Power Down released

* Application and removal of AC mains from the amplifier are recorded. Note that use of the front panel power switch is not recorded.

The last five events are displayed per page, with the most recent at the top of the list. The log retains the last 256 events; if the list exceeds this size, the oldest events are deleted. Earlier pages may be scrolled through with the **>>** and **<<** buttons. The log may be cleared at any time by clicking the **Clear Log** button.

The Config Menu

The Config menu is divided into 13 submenus:

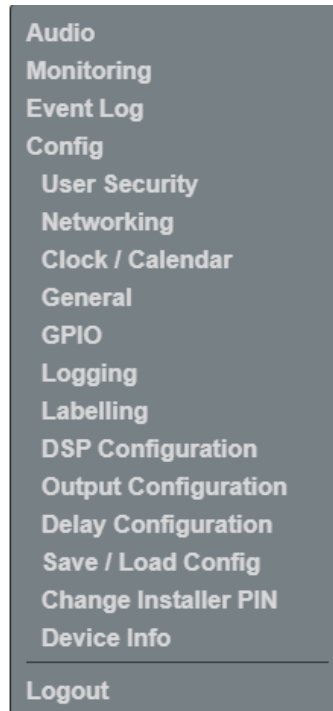

The DSP Configuration page is described at “Submenu: DSP Configuration” on page 28.

Output Configuration

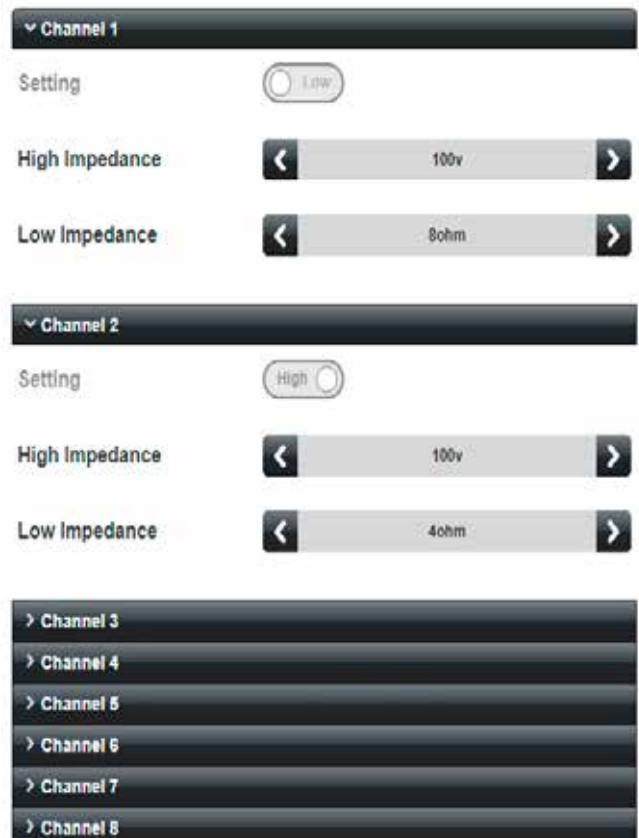

Submenu: User Security

Expanding the **User Security** menu item opens the list of Users:

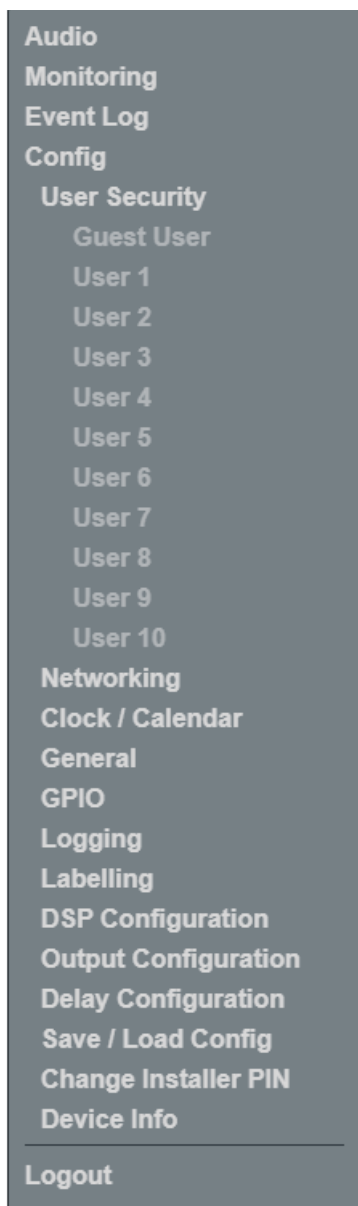

The User security system allows up to ten Users - *in addition to the Installer* - unique PIN access to the control pages. Additionally, a Guest User may access the control pages without a PIN. Clicking on any of **User 1** to **User 10** opens the User privileges page for that User:

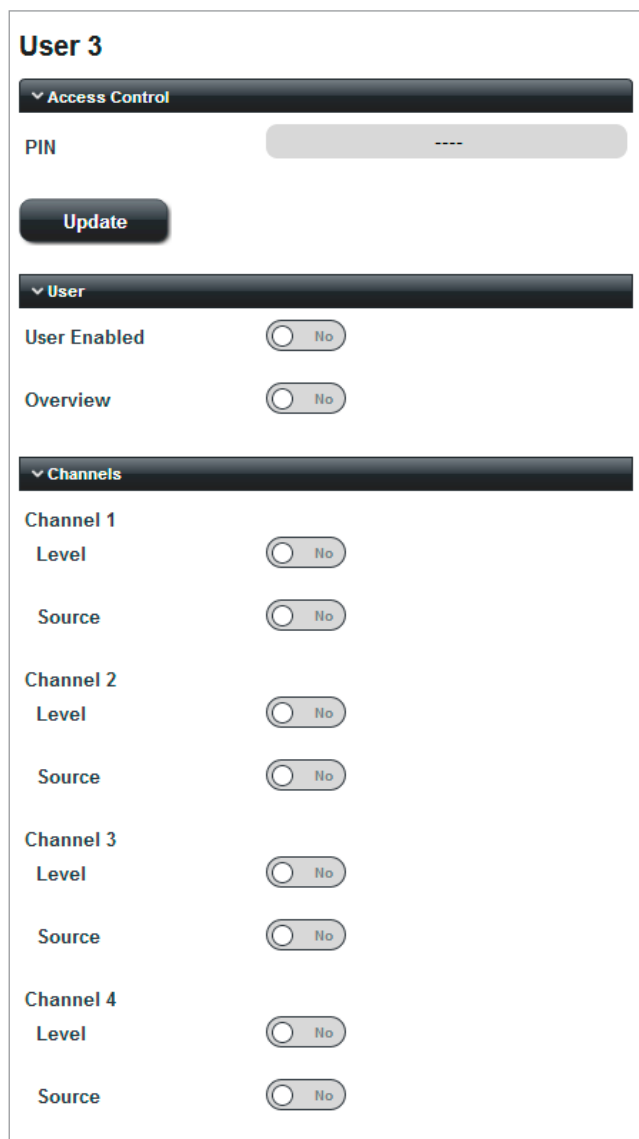

Note that only an Installer may define Users and change their access privileges.

The flexibility of the security system allows a client – if they wish - to give particular members of staff access to source and level control for each amplifier only for certain channels: these will typically correspond to particular areas of the building. Access privileges may be defined individually for each User.

To define User privileges, click in the **PIN** field under the **Access Control** tab, delete the default hyphens and then enter a PIN for the User. Click **Update** – a confirmation message will appear. Under the **User** tab, the **User Enabled** switch must be set to **Yes** to enable the new User PIN, and for the functions displayed below to take effect. Setting **Overview** to **Yes** means the User will see the **Overview** page as a landing page when they log in, but only those functions that have been enabled for software control by setting their **Rear Panel** switches to **No** will be displayed..

The switches under the **Channels** tab define the per-channel control functions that will be available for the User

to control. Set the **Level** and **Source** switches to **Yes** or **No** (the default setting) for each amplifier channel as desired, but note that unless each control function enabled for access by the User is enabled (*by the Installer*) for software control on the individual Channel pages, they will remain invisible to the User.

Once User privileges have been defined, the User(s) may log on using their own PINs, and will be presented with page layouts displaying only those functions which their access privileges allow, and which have also been enabled by the Installer for software control. An example is shown below, where User 2 has been given access to input source selection of Channels 1, 2 and 3 but output level (and consequently, **Mute**) as well of Channels 2 and 3 only. User 2's **Overview** page will look like this:

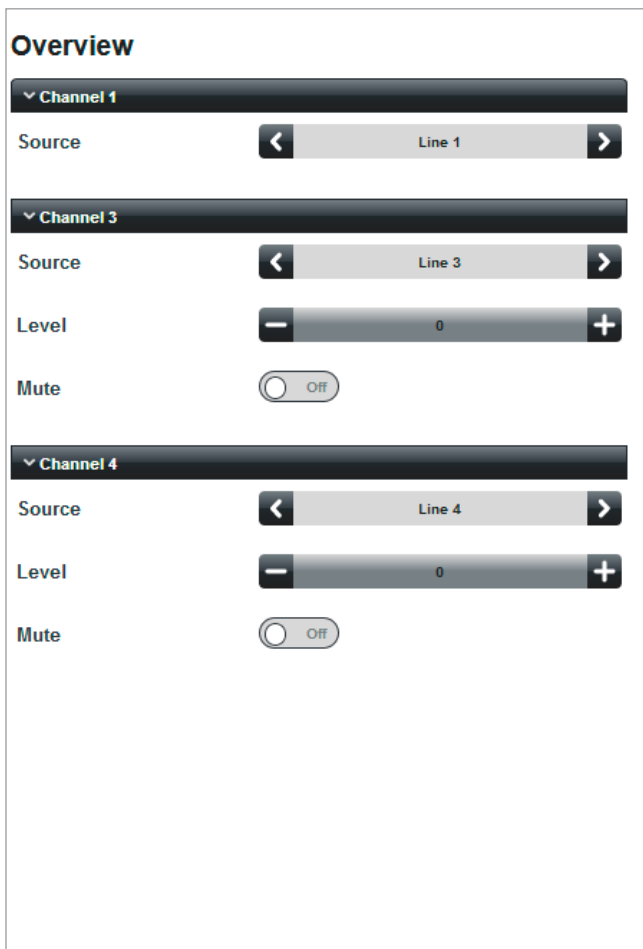

Users will see a main menu as below – note that most of the **Config** submenu options are not available.

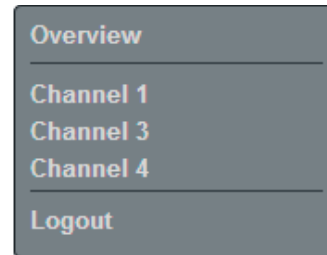

A User PIN may be changed by the Installer at any time from the **User Security** page for the specific User by deleting the current PIN – which will be displayed in the **PIN** field, entering a new PIN and clicking **Update** again. A confirmation message will be displayed.

Guest User

The security system provides for one additional User – the **Guest User**.

If User Enabled is active for the Guest User, it is possible to browse to the web interface pages without a PIN being requested. However, as with any other User, only those functions that have been assigned by an Installer will be available. The Guest User has been included to allow casual access to unit functionality without a PIN logon.

Submenu: Networking

The **Network Configuration** page displays the current network settings for the amplifier, and allows them to be changed.

TCP/IP Address tab

The current **IP Address**, **Subnet Mask**, **Gateway** address and **Unit Name** are confirmed. If **DHCP** is set to **On**, the values in **IP Address**, **Subnet Mask** and **Gateway** are set automatically and the fields greyed out. If assigning these values (with **DHCP** set to **off**), ensure that a suitable, reserved static IP address is used. This may require consultation with the network administrator.

Identity tab

Unit Name – this field has a default value of **CVA2500**, **CVA4250**, **CVA6160** or **CVA8125**, depending on the amplifier model. In an installation where several CVA Digital amplifiers are installed, it will probably be more helpful if each is given a more meaningful name, e.g., relating to the use to which the amplifier is being put.

Reset and Upload

Click the **Reset** button (at the bottom of the page; scroll down if not visible) to reset the page to the previous state if any changes have been made but not uploaded. Click the **Upload** button to transfer any changes to the amplifier.

Server Ports tab

In the vast majority of installations, the network parameters on this tab will not need adjustment. However, they are likely to become relevant if the amplifier is connected to an existing IT network. The correct settings for these items will vary from one installation to another, and we recommend that the network administrator is consulted as to the appropriate values.

HTTP Port – this is the virtual port that a browser will connect to. The default is universally “80”. It is sometimes changed for firewalling or “security by obscurity” reasons. If this is the case, the value has to be specified in the browser URL with a colon, e.g., <http://cloud.co.uk:9000/> would be required if the HTTP port was set to 9000.

Bridge Port – this is the TCP/IP port used by the amplifier’s **Ethernet to Serial Bridge** functionality. See “Using the amplifier as an Ethernet-to-serial bridge” on page 51 for more details.

TCP Parser Port – this is the TCP/IP port used to receive serial control commands via Ethernet (instead of via the RS-232 port)

UDP Parser Port – this is the port used to receive serial control commands via the UDP layer of TCP/IP. This is useful for broadcast and multicast control applications.

Multicast Address – this is the address of the multicast group to be used for serial commands via UDP, if the Multicast switch is set to **On**.

SNMP tab

CVA Digital amplifiers are compatible with system monitoring software employing the SNMP protocol. Cloud Electronics software and MIBs for the CVA Digital amplifier range can be downloaded from the product page at www.cloud.co.uk. Once these are loaded into SNMP browser / management software, the available SNMP parameters will become available.

Submenu: Clock / Calendar

The amplifier includes a real-time clock, which continues to run when the unit is unpowered. It allows the amplifier to be programmed to automatically enter and exit Automatic Power Down Mode at the same time every day – or only on certain days. This is of great advantage in museums, theme parks and similar attractions, where exhibits are required to operate on a fixed schedule. It is also useful where input signals are always present, as the scheduler will override the action of the Automatic Power Down feature, which would otherwise prevent the amplifier from ever turning off.

The **Clock / Calendar** page has two tabs: **Date / Time** and **Scheduler**.

Date / Time tab

- **Unit Date/Time** - shows the current date and time of the amplifier's internal clock.
- **Local Date/Time** - shows the current date and time of the clock of the device hosting the browser.
- **set** - click this button to synchronise the amplifier's clock with the device's clock.

Scheduler tab

- **Enable** – the Scheduler will only be active if **Enable** is set to **On**. If **Enable** is **Off**, the application of a music signal, a “wake” command to the serial port or via Ethernet, or a command to the **REMOTE PWR DOWN** port will wake the amplifier.
- **Wake time** – use the **Hour** and **Minute** selectors to set the time at which the amplifier should “wake up”, i.e., be available for operation. The scheduler uses 24-hour format, and the time can be set in 15-minute increments.
- **Sleep Time** – set the time at which the amplifier should “go to sleep”, i.e., enter Standby Mode in the same way.
- **Days** – set the switches for the days of the week on which the amplifier is required to operate.
- **save** – click this button to confirm the times programmed into the scheduler.

Submenu: General

The **General Settings** page is used to set the baud rate of the amplifier's serial port and also to disable the Auto Power-down due to lack of input signal activity.



The default rate is 9600. Use the **Baud Rate** selector to set an alternative rate; the available options are 4800, 19200, 38400, 57600 and 115200.

See "Serial Control of CVA Digital Amplifiers" on page 49 for more details about using the amplifier's serial port.

Note about disabling Auto power-down (APD). The amplifier will consume more power during periods of inactivity, with APD disabled, but will respond immediately when the input signal is re-instated. This setting may be advantageous for paging-only applications, which might otherwise require a pause before the announcement, to allow the amplifier to wake from standby.

Submenu: GPIO

The **GPIO Setup** page permits configuration of the GPIO port.



The port has three separate pins (GPIO 1, GPIO 2 and GPIO 3), each which may be configured in one of four ways – two input options and two output options. See "The GPIO Port" on page 48 for electrical and connection details of the GPIO port.

The **GPIO Setup** page has a selector for each of the three pins. The available options are the same for each:

- **Mute all (Input)** – the pin is configured as an input, and applying a logic low, i.e. connecting the contact to 0 V, will mute all amplifier channels while the low is applied.
- **Fault (Output)** – the pin is configured as an output, and a logic low (<0.5 V) will be present if any channel should enter Protect Mode.
- **User (Input)** – the pin is configured as an input, and its logic state can be reported via a serial message to an external control system. An external switch or sensor can be connected to the pin and used as a local switch input to the control system. The control system is programmed to poll the GPIO port and the amplifier will respond with a serial string confirming the pin's current logic state.

- **User (Output)** – the pin is configured as an output, and can be set logic high or logic low in response to a serial command from the control system. It can then be used to operate local indicators or as a trigger for other equipment.

The status of the GPIO port is continuously monitored and displayed on the **Monitoring** browser page.

Submenu: Logging

The **Logging** page is used in conjunction with the **Event Log** page (see "Event Log" on page 40).

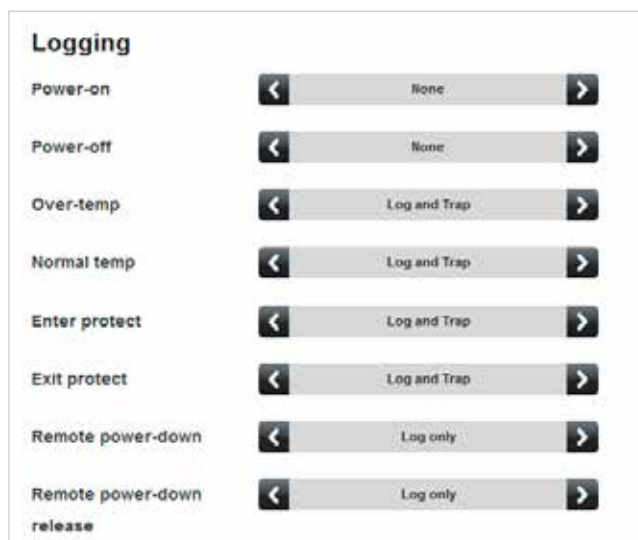

The eight critical event types that may be recorded in the Event Log are listed: each has a selector switch offering the following three options:

- **None** – events of this type are ignored.
- **Log only** – events of this type are recorded in the Event Log.
- **Log and Trap** – events of this type are recorded in the Event Log, and SNMP data about the event is also transmitted to the SNMP Trap Host as configured on the Networking page.

The settings in the example shown above would cause AC power on/off events to be ignored but would record all other critical events. In addition, the statuses of temperature and Protect Mode would transmit SNMP traps to external monitoring equipment.

Submenu: Labelling

The **Labels** page allows the Installer to change the names of the line inputs, the DSP blocks and the amplifier itself. Names entered on the **Labels** page will replace the default names on all browser pages where they appear. This provides a much more intuitive interface.

Renaming is simply a matter of deleting the default name in the field(s) (use backspace) and entering the new name(s). Clicking the **Save** button will upload all the labels simultaneously; the names are loaded into non-volatile memory in the amplifier. The **Reset** button reloads the **Labels** page from the amplifier, and thus may be used to discard any changes that have been made to the labels on-screen since the last click of the **Save** button.

The page is divided into four tabs:

- **Unit Label** – a name entered here will be reported as the answer to a serial command query, and is useful for confirming unit identity to a control system when there are multiple units on the network.
- **Line Inputs** – the sources connected to each of the Line Inputs may be identified here; their names will then appear on all the Input Source selectors on the Audio pages.

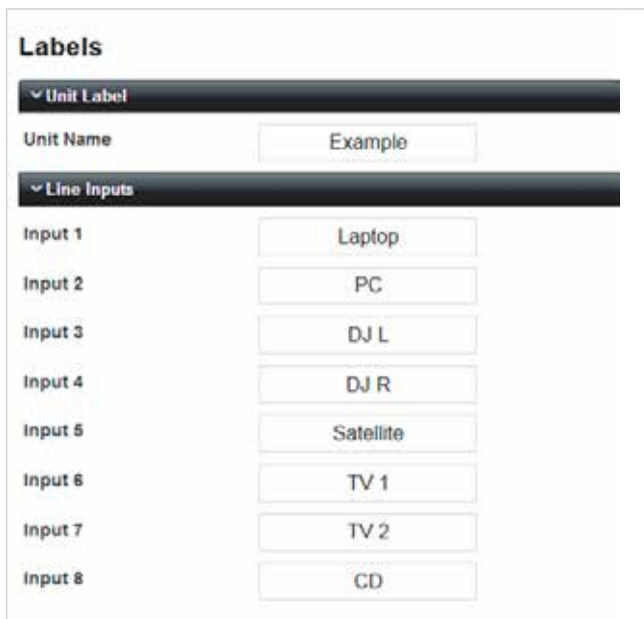

Example from Model CVA8125

- **Auxiliary Inputs** – these are only used if the optional CDI-8D Dante® input card is fitted.
- **DSP Block labels** – the DSP Blocks can be given names here; if the DSP Blocks retain their default configuration of Mono + Mono, these will effectively be the names of the amplifier channels. Block labels can be used to identify the areas of the premises in which each block is used to drive speakers. Note that the listing of the DSP blocks reflects the DSP Block configuration: in the example below (from a CVA8125), Blocks 7 and 8 are configured as a stereo pair. Note also that renaming the DSP blocks is reflected in the Audio drop-down menu:

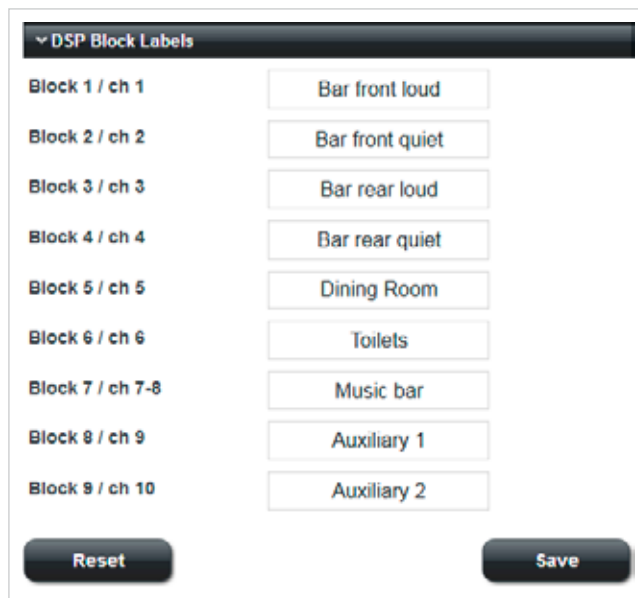
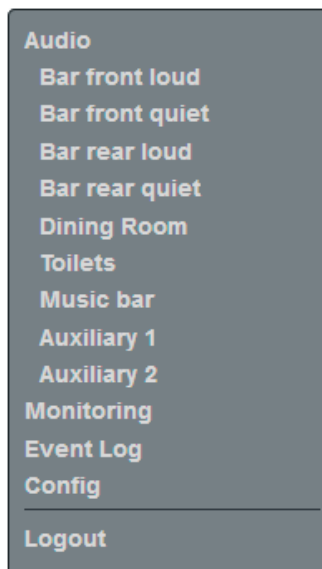
Submenu: Delay Configuration

CVA Digital Series amplifiers permit the insertion of user-defined amounts of time delay into each channel, including the Auxiliary Outputs. These permit the accurate time-alignment of multiple loudspeakers in the same space.

The DSP section incorporates a total of 1482 ms of delay, which is freely available to all the DSP blocks in any proportion. Note that this is a “pool” of delay: 1482 ms is the total delay available, which can be distributed between DSP blocks as required.

The **Delay Configuration** page lists the amplifier channels, and reflects the DSP block configurations (and any renaming) currently in force. In the CVA8125 example shown below, all the main amplifier channels are configured as stereo pairs; the Auxiliary Outputs remain in mono.

| Units | ms |
|----------------|-------|
| Channels 1 - 2 | 20 ms |
| Channels 3 - 4 | 25 ms |
| Channels 5 - 6 | 35 ms |
| Channels 7 - 8 | 10 ms |
| Auxiliary 1 | 0 ms |
| Auxiliary 2 | 0 ms |

Delay is implemented by entering the delay time in each field as required.

Note that the total delay that has been applied to the eight amplifier channels in the above example is 180 ms; the **Delay Allocation** tab header shows this figure.

When delay is applied to channels making up a Stereo DSP Block, each of the two channels has the same delay added. However, when delay is applied to channels making up a Crossover DSP Block, a single delay is added to the input signal: that is, one channel in the case of a mono crossover, and two in the case of a stereo crossover.

Default delay units are milliseconds (ms); use the Units selector to choose an alternative: **Metres** and **Feet** are available. The distance calculation is based on the standard speed of sound of 343.3 m/s (1126 ft/s).

Submenu: Save/Load Config

Selecting **Save/Load Config** opens the **Import / Export Settings** page.

This lets you save the current unit settings to a file and also to reload the settings into the amplifier. This feature will be particularly useful when installing a system with several amplifiers, all of which need to be configured similarly.

Under the **Export Settings File** tab, click **Export** to download the current CVA Digital amplifier settings to the computer or other device being used to access the web pages. The browser will treat the file in the same manner as all downloadable files, and may present an intermidate file dialoge page.

The file will always be called `settings.CVA_config` and your device will save it to the default folder used for downloads.

To load a previously saved settings file into the amplifier, open the **Import Settings File** tab, and click the **...** button. This will open a standard file window: navigate to the settings file and select it. Click **Import** to upload the settings into the amplifier: a confirmation message will be given when the upload is complete.

Submenu: Change Installer PIN

Change Installer PIN

Logged in as: **Installer**

Enter your current PIN:

Add a new PIN:

Confirm your new PIN:

This page lets you change the Installer PIN. You will need to confirm the current PIN in the **Enter your current PIN** field before proceeding to enter a new one in both the **Add a new PIN** and the **Confirm your new PIN** fields, and Click the **Update** button.

If the Installer PIN is forgotten or lost, a factory reset (see page 12) will reset it to 1234.

Submenu: Device Info

Select **Device Info** from the menu to open the Device Information page.

Device Information

▼ Build Information

Build Version:

Build Date:

▼ Version Information

Server Firmware:

Server Pages:

Server Hardware:

This is an “Engineering” page which gives details of the versions of the various firmware elements in the amplifier. This information may be requested by Cloud’s Technical Department in the event of problems with the amplifier.

Additional Amplifier Functions

The GPIO Port

CVA Digital amplifiers are equipped with a 3-way GPIO port. This may used to connect to external equipment, such as control systems, indicators, relays, user switches, etc., for a variety of purposes that the installation may require.

The pinout of the rear panel **GPIO** connector is as follows:

| PIN | FUNCTION |
|-----|----------|
| 1 | 0 V |
| 2 | GPIO 1 |
| 3 | GPIO 2 |
| 4 | GPIO 3 |
| 5 | + 15 V |

Each of pins 2, 3 and 4 may be configured as either an input or an output. This is done through the browser pages; select **Config > GPIO** from the main menu. See “Submenu: GPIO” on page 45 for details of the various options.

The factory default is with all three pins configured as Mute Inputs. In this state, each of the three pins has the same function, to mute all amplifier channels.

GPIO Inputs

When a GPIO pin is configured as an input, either for amplifier muting or as a User Input, the pin should be shorted to ground (pin 1) to effect the input command. The pin has a high-impedance internal pull-up to +15 V.

GPIO outputs

When a GPIO pin is configured as an output, either for fault signalisation or as a User Output, the pin goes low (<0.5 V) when the GPIO output is active. The output uses a FET in open-drain mode, and may be used to drive relays and other external devices with a maximum rating of 24 V and 1 A. If the pin is used to drive a relay, we recommend a back-EMF diode is connected across the relay coil in the usual manner.

Note that the status of the GPIO pins can be inspected at any time on the **Rear Panel Controls** tab of the **Monitoring** browser page: see “Monitoring” on page 39 for details.

Serial Control of CVA Digital Amplifiers

CVA Digital amplifiers are equipped with a bi-directional RS-232 serial interface.

As a receiver, the interface permits external control of almost every amplifier function, and largely replicates the facilities available through the browser interface. The amplifier appears as a DCE (Data Communications Equipment) device to controlling equipment. As the controlling device will probably be configured as a DTE device, a straight (uncrossed)* cable will probably be required (but see note under "Pinout" below).

*A straight cable has the Tx (Data Transmit) pins at the two cable ends connected to each other and the Rx pins (Data Receive) similarly connected to each other.

The full RS-232 protocol is beyond the scope of this manual, but it can be downloaded from www.cloud.co.uk.

This section provides only serial port details and an abridged serial command list.

Pinout

The rear panel **RS232** connector is a 3-pin, 3.5 mm-pitch screw-terminal connector. The pinout is shown in the table:

| PIN | LABEL | FUNCTION |
|-----|-------|------------------------------------|
| 1 | 0V | Ground |
| 2 | Rx | Data transmit (to control system) |
| 3 | Tx | Data receive (from control system) |

Note that not all control systems interpret "Tx" and "Rx" the same way, and the installer should always check whether pins 2 and 3 should be "crossed" within the cable.

Port parameters:

| Parameter | VALUE/SETTING |
|-------------|--|
| Data type: | RS-232C serial |
| Data speed | 4800/9600/19200/38400/57600/115200 baud, software-selectable |
| Word length | 8 bits |
| Parity | None |
| Stop bits | One |

The amplifier is additionally able to receive the same serial commands in the form of TCP/IP data via the **ETHERNET INTERFACE** connector.

Block numbers

Most serial commands controlling audio functions operate on configured DSP Blocks. "Out-of-the-box", each channel may be considered as an independent mono DSP Block, but if DSP Blocks have been redefined through the web browser pages as stereo or crossover configurations, the commands will affect all channels comprising the Block.

This gives rise to the concept of "Block numbers": in the "out-of-the-box" configuration where all channels are mono, Channel numbers and Block numbers have a 1:1 relationship.

Now consider a CVA 8125 amplifier that has been reconfigured to provide a selection of mono, stereo and crossover channel sets:



In this example, the audio drop down menu appears like this:

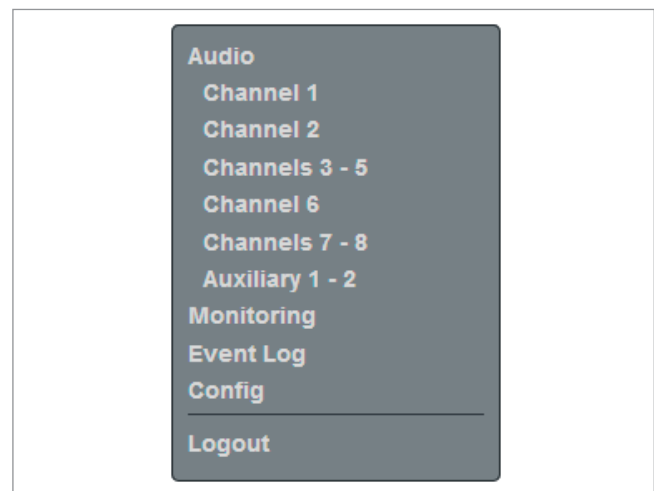

The Block numbers used in serial commands will be assigned in straight "ascending" order as follows:

| Channels | Block number |
|-----------|--------------|
| 1 | 1 |
| 2 | 2 |
| 3 - 5 | 3 |
| 6 | 4 |
| 7 - 8 | 5 |
| Aux 1 - 2 | 6 |

Examples:

Abridged command set

The commands listed in the table below are some of those most likely to be required when controlling a CVA Digital amplifier from an AV control system. For all other commands, data requests and responses, please refer to the full RS-232 protocol document. Note that the examples apply to a CVA8125; for models with fewer channels, the higher Block and Line Input numbers can be ignored.

| GENERAL FORMAT | | COMMENTS |
|--|-----------------------------|---|
| FUNCTION | COMMAND (ASCII) | |
| Power Up | <SY,PU/> | |
| Power Down | <SY,PD/> | |
| Wake from APD Mode | <SY,WU/> | |
| Enable input source selection for Block <i>n</i> | <B <i>n</i> , SE/> | n/a to Aux Outputs |
| Disable input source selection for Block <i>n</i> | <B <i>n</i> , SX/> | |
| Select Block <i>n</i> source to Input <i>x</i> (see Example 1) | <B <i>n</i> , S <i>x</i> /> | |
| Enable level control of Block <i>n</i> | <B <i>n</i> , LE/> | n/a to Aux Outputs |
| Disable level control of Block <i>n</i> | <B <i>n</i> , LX/> | |
| Increase level of Block <i>n</i> by <i>p</i> dB | <B <i>n</i> , LUp/> | Ignored by Blocks containing Aux Outputs if their source and level are slaved |
| Decrease level of Block <i>n</i> by <i>q</i> dB | <B <i>n</i> . LDq/> | |
| Mute Block <i>n</i> | <B <i>n</i> , M/> | |
| Unmute Block <i>n</i> | <B <i>n</i> , O/> | |

1. Input Selection:

Because serial control largely follows the formats of the web browser pages, most of the audio control functions need to be enabled for external control before adjustment, if they are not already enabled. The first of the two serial commands shown below enables input selection for external control of Block 1 (in this case, via the serial port).

| EXAMPLES | COMMAND (ASCII) |
|------------------------------------|--------------------|
| Enable input selection for Block 1 | <B1, SE/> |
| Select an input source for Block 1 | <B1, S <i>x</i> /> |

The value of *x* in the Select input source command is as follows:

| <i>x</i> | Result |
|----------|--------------------------------------|
| 0 | Block 1 has no input |
| 1 | Block 1 is sourced from Line Input 1 |
| 2 | Block 1 is sourced from Line Input 2 |
| 3 | Block 1 is sourced from Line Input 3 |
| 4 | Block 1 is sourced from Line Input 4 |
| 5 | Block 1 is sourced from Line Input 5 |
| 6 | Block 1 is sourced from Line Input 6 |
| 7 | Block 1 is sourced from Line Input 7 |
| 8 | Block 1 is sourced from Line Input 8 |

2. Output Levels:

Audio levels in each Block can either be set to an absolute value (in dBs), or increased/decreased by a specified number of dBs. Either may be defined in steps of 1 dB.

For absolute levels, the number of dBs corresponds to attenuation rather than gain, thus 0 dB is maximum level and at -90 dB the zone is muted.

To alter the Block's level by a specified amount, the additional ASCII characters 'U' (up) or 'D' (down) are added to the string. The values of *p* and *q* are the number of single-dB steps (0 to 90) up or down respectively. A command to increment the level by a number of dBs greater than the current attenuation

will set the level to maximum. Similarly, a command that would decrement the level below 90 dB attenuation will mute the Zone output.

| EXAMPLES | COMMAND (ASCII) |
|-----------------------------------|-----------------|
| Enable level control for Block 3 | <B3,LE/> |
| Set level of Block 4 to -12 dB | <B4,L12/> |
| Reduce level of Block 1 by 10 dB | <B1,LD10/> |
| Increase level of Block 2 by 6 dB | <B2,LU6/> |

Using the amplifier as an Ethernet-to-serial bridge

The CVA Digital amplifier may be used as an Ethernet-to-serial bridge. Many AV control systems now transmit serial data strings in TCP/IP format via an Ethernet interface, rather than from an RS-232 port. However, some equipment – projectors and other display devices, for example – only accept serial control via an RS-232 port.

The amplifier can receive serial data at the Ethernet port and re-transmit it from the RS-232 port, and thus act as an Ethernet-to-serial converter or bridge.

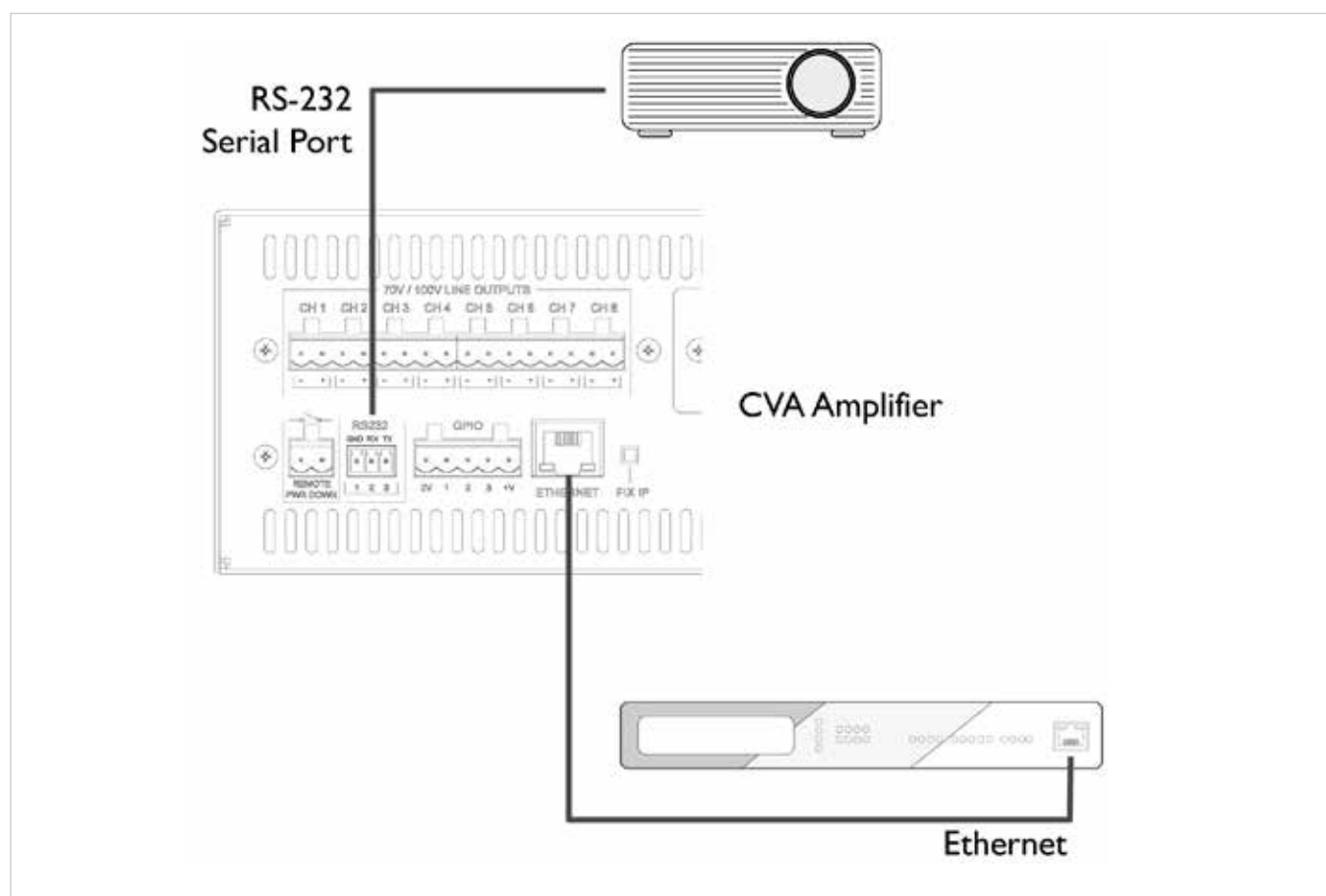

This function uses the amplifier's Bridge Port, whose address has the default value of 4998. If the controlling device is only able to support remote ports in a certain address range (i.e., not including 4998), the port address can be changed on the **Network Configuration** page of the browser interface (select **Config** > **Networking**).

APPENDIX

RL-1 Series remote control plates – general considerations

Cloud RL-1 Series remote control plates are available in three form factors, two fit single-gang UK or American electrical back boxes respectively; the third is a 50 x 50 mm “Media” module, suitable for “Euro-module” mounting frames available in most European countries. Back boxes of either the recessed type or surface-mounting type may be used, providing they are at least 25 mm deep.

The plates should be connected to the **REMOTE LEVEL** port of the relevant channel using twin-core screened cable as described at “Connecting an RL-1 Series remote control plate” on page 17. The plate terminations are conventional screw terminals and the **REMOTE LEVEL** port on the mixer is a 3-pin 5 mm-pitch screw terminal connector.

The remote control plates are passive and thus do not draw any current from the amplifier.

Control of audio level via external DC

It may be necessary in some installations to adjust the level of one or more channels from an external control system. If the **REMOTE LEVEL** ports are not required for RL-1 Series remote control plates, they may be used to receive DC voltages from the external system to effect these adjustments.

Audio level can be controlled over its full range with a DC voltage of 0 to +10 V. The pinout of the **REMOTE LEVEL** port is as follows:

| PIN | USE |
|-----|----------------------------------|
| 1 | 0 V ref. |
| 2 | Music level control (0 to +10 V) |
| 3 | +V |

The audio level of a Block may be varied over its full range by applying a DC voltage of between 0 and +10 V to pin 2, the 0 V reference being connected to Pin 1. 0 V on pin 2 will produce maximum level and +10 V will produce maximum attenuation, i.e., no output.

Note that if pin 2 is left unconnected and the **REMOTE LEVEL** port enabled (e.g., with the mating connector left off), zero attenuation results.

NOTE: If the control voltage source is not isolated from the power earth, there is a small risk of creating a ‘ground loop’ by linking the mixer technical ground (0 V) to the ground (0 V) of the equipment supplying the control voltages. To minimise this risk, we suggest that all pieces of equipment be in close proximity, and supplied from the same power outlet.

Technical Specifications

| Performance | | All Models | | | |
|-------------|---------------------------------|--|-------------------------------|-------------------------------|-------------------------------|
| | Output Power | Total output power 1 kW, all channels ¹ | | | |
| | Output Voltage | 70 V or 100 V (rms) and 4Ω / 8Ω / 16Ω low-impedance | | | |
| | Frequency Response | 20 Hz to 20 kHz, +/-0.5 dB | | | |
| | High Pass Filter | -3 dB @ 65 Hz via rear panel switches -3 dB @ 20 Hz to 200 Hz via DSP configuration | | | |
| | Distortion | 0.03%THD @1 kHz, 1 dB below rated output | | | |
| | Noise | -94 dB, 22 Hz to 22 kHz | | | |
| | Crosstalk | < -90 dB @1 kHz, -82 dB @10 kHz adjacent channels <-107 dB @1 kHz, -93 dB @10 kHz non-adjacent channels All tested with 125 W load | | | |
| Inputs | | | | | |
| | Connectors | 3-pole 3.5 mm-pitch plug-in screw-terminal connectors | | | |
| | Sensitivity | 0 dBu (0.775 V _{rms}) | | | |
| | Input Impedance | 10 kohms (balanced); 5 kohms (unbalanced) | | | |
| General | | | | | |
| | Output connectors | 2-pole 5 mm-pitch plug-in screw-terminal connectors | | | |
| | Remote level control connectors | 3-pole 5 mm-pitch plug-in screw-terminal connectors Compatible with Cloud RL Series remote control plates | | | |
| | Power input | 85 to 264 V AC, 40 to 60 Hz | | | |
| | Mains protection | Class 3T 250 V fuse, 20 x 5 mm, rating T8A | | | |
| | Normal Operating Temperature | 0 °C to 35 °C (Note performance and specifications cannot be guaranteed outside this range) | | | |
| | Power Consumption | | CVA2500 | CVA4250 | CVA8125 |
| | | Standby ² | 2.34 W, 12.4 VA | 2.43 W, 24.0 VA | 2.5 W, 24.4 VA |
| | | Idle ³ | 27.1 W, 46.7 VA | 38.9 W, 60.0 VA | 59.7 W, 89.3 VA |
| | | 1/8th power ⁴ | 164.2 W, 201.3 VA | 187.4 W, 227.2 VA | 207.0 W, 248.8 VA |
| | | 1/3rd power ⁵ | 380.7 W, 421.1 VA | 330.1 W, 368.8 VA | 352.6 W, 387.5 VA |
| | Heat Loss | Standby ² | 8.4 KJ/hr (8.0 BTU/hr) | 8.7 KJ/hr (8.3 BTU/hr) | 9.1 KJ/hr (8.7 BTU/hr) |
| | | Idle ³ | 97.3 KJ/hr (92.5 BTU/hr) | 140.1 KJ/hr (132.9 BTU/hr) | 215.0 KJ/hr (203.9 BTU/hr) |
| | | 1/8th power ⁴ | 179 KJ/hr (169.7 BTU/hr) | 217.9 KJ/hr (206.7 BTU/hr) | 278.7 KJ/hr (264.3 BTU/hr) |
| | | 1/3rd power ⁵ | 293.3 KJ/hr (278.7 BTU/hr) | 263.5 KJ/hr (249.9 BTU/hr) | 334.4 KJ/hr (317.1 BTU/hr) |

Technical Specifications are continued on following page.

| General (continued) | | | | |
|---------------------------|----------|---|-----------------------|------------------------|
| Amplifier Protection | | Overcurrent DC Thermal monitoring and limiting Switch-on delay | | |
| Status Indicators | | Power applied / Thermal limiter, Protection active, Signal peak, and Signal present | | |
| Cooling | | Variable speed fan | | |
| Dimensions (W x H x D) | Net | 482.6 mm x 88 mm x 381.8 mm (19 in x 3.46 in x 15.03 in) | | |
| | Shipping | 606 mm x 164 mm x 558 mm (23.9 in x 6.5 in x 22 in) | | |
| Weight | | CVA2500 | CVA4250 | CVA8125 |
| | Net | 6.86 kg (15.37 lb) | 7.26 kg (16.26 lb) | 8.05 kg (18.03 lb) |
| | Shipping | 8.86 kg (19.85 lb) | 9.26 kg (20.74 lb) | 10.05 kg (22.51 lb) |

1. Odd- and even-numbered channel groups can deliver up to 500 W simultaneously, but in models with more than two channels, the available power is reduced proportionately when any channel is delivering more than its nominal rating.

Notes re Power Consumption and Heat Loss measurements: All measurements at 230 VAC 50 Hz power input

2. Standby: amplifier in standby state
3. Idle: amplifier not in standby state, but no audio output
4. 1/8th Power: constant sound level at 1/8 of the rated output power (audio mainly clean, only occasional clipping)
5. 1/3rd Power: constant sound level at 1/3 of the rated output power (audio beginning to become compressed, limited or heavily clipped)

Table of factory settings

The amplifier will adopt the following settings when a Factory Reset is carried out (see "Factory Reset" on page 13).

| | LOCATION | CONTROL | STATE |
|----------------------|-----------------------|------------------|--|
| Main channels | Input Routing | Rear Panel | Enabled |
| | Room EQ | | Disabled |
| | High Pass Filter | Rear Panel | Enabled |
| | | Cutoff frequency | 65 Hz |
| | | Polarity | Non-inverted |
| | Speaker EQ | | Disabled |
| | Output Level | Rear Panel | Yes |
| Limiter | Threshold | 0 dB | |
| Auxiliary Outputs | Input Routing | Slave | Yes |
| | | Master | Aux 1 = Channel 1 Aux 2 = Channel 2 |
| | Room EQ | | Disabled |
| | Filter Type | | None |
| | High Pass Filter | Enabled | No |
| | | Polarity | Non-inverted |
| | Speaker EQ | | Disabled |
| | Output | Slave Level | Yes |
| Slave Mute | | Yes | |
| Networking | TCP/IP Address | DHCP | On |
| | Identity | Unit Name | Model type |
| | SNMP | Enabled | On |
| General Settings | RS232 | Baud Rate | 9600 |
| | Auto Power Down | Enabled | Yes |
| GPIO Setup | GPIO 1 – 3 | | Mute all (Input) |
| | | | |
| Logging | All event types | | Log only |
| DSP configuration | Configured DSP Blocks | | Mono + Mono (number depends on model) |
| Output Configuration | Main Channels | High Impedance | 100v |
| | | Low Impedance | 4 Ω |
| Delay Configuration | All Channels | | Unassigned |
| | Units | | ms |

www.cloud.co.uk

cloud

MADE IN BRITAIN 