

CS-S4 4" Surface-mount Loudspeaker

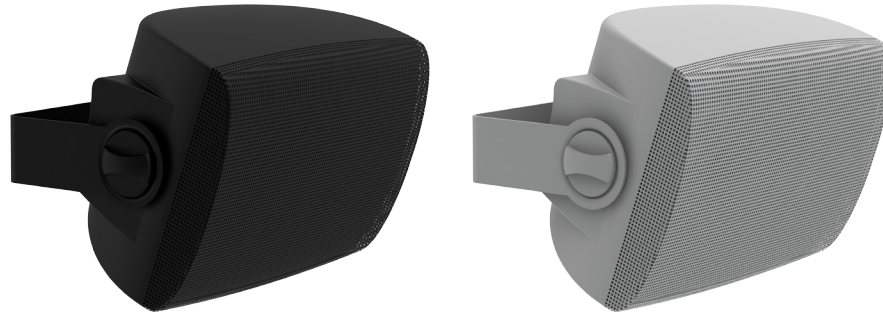

General Description

The Cloud CS-S4 is a 4.0 inch coaxial two way surface mount loudspeaker featuring exceptional intelligibility and musical performance. Suitable for internal or outdoor use, the CS-S4 conforms to IP rating IP55 (protection from limited dust ingress, and low pressure water jets from any direction) when fitted with the supplied port plug. Using premium drivers and electronics, the CS-S4 offers high sensitivity, smooth frequency response, and excellent off axis performance. The 4.0 inch woofer incorporates a large magnet structure, a polypropylene cone, and a butyl rubber surround for lasting, low distortion performance. The 19mm (0,75 in) soft dome tweeter contributes to the smooth distribution of off axis HF energy. The included 20W transformer provides plenty of power for background to foreground applications. The 16 ohm impedance allows for easy low impedance daisy chaining.

- Easy access front mounted tap switch
- Premium drivers and electronics for exceptional sound quality and intelligibility
- Integrated high power transformer with bypass
- 16 ohm for low impedance daisy chaining
- Designed to mount vertically and horizontally
- Coaxial drivers for optimal off axis performance
- 4-pin Euroblock connectors
- Corrosion resistant Aluminum grille and U-bracket

Speaker Dimensions

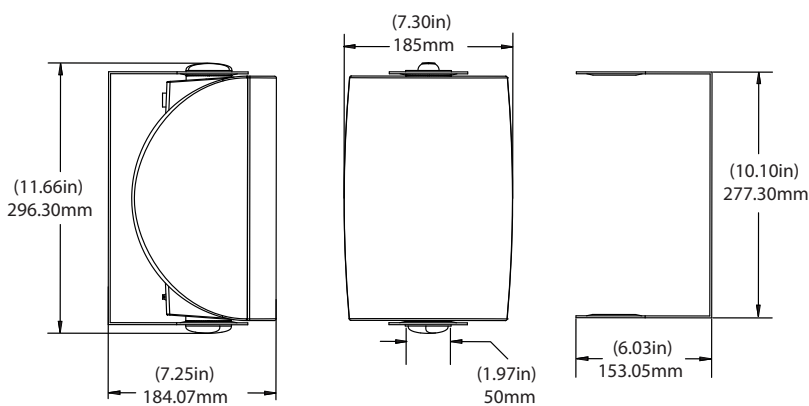

Speaker Enclosure

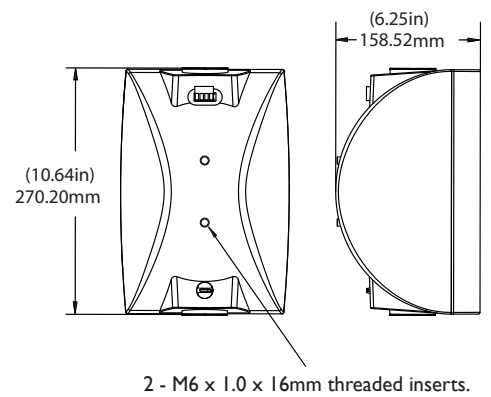

Speaker Bracket

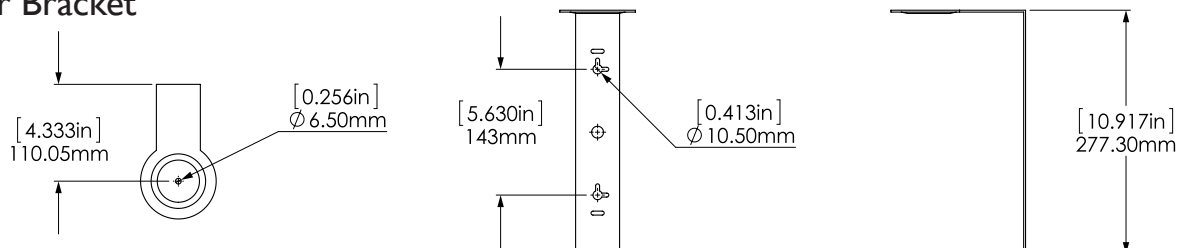

Applications

The CS-S4 was developed as a versatile background music and mid-SPL paging speaker. It offers superior acoustic performance, and premium design at an economic price point. It is ideally suited for use in restaurants, retail stores, airports, churches, board rooms, health care facilities, and hotels. The entire CS-S series shares the same acoustic signature, so installations with varying SPL requirements can seamlessly integrate multiple models from the line. The CS-S4 is a premium background and paging speaker that offers high end performance and design at an affordable price point.

Tap Settings

Tap	Tap Settings		
	100V	70V	25V
1	16 ohm		
2	X	20W	2.5W
3	20W	10W	1.3W
4	10W	5W	0.6W
5	5W	2.5W	0.3W
6	2.5W	1.3W	0.2W

Graphs

Frequency Response

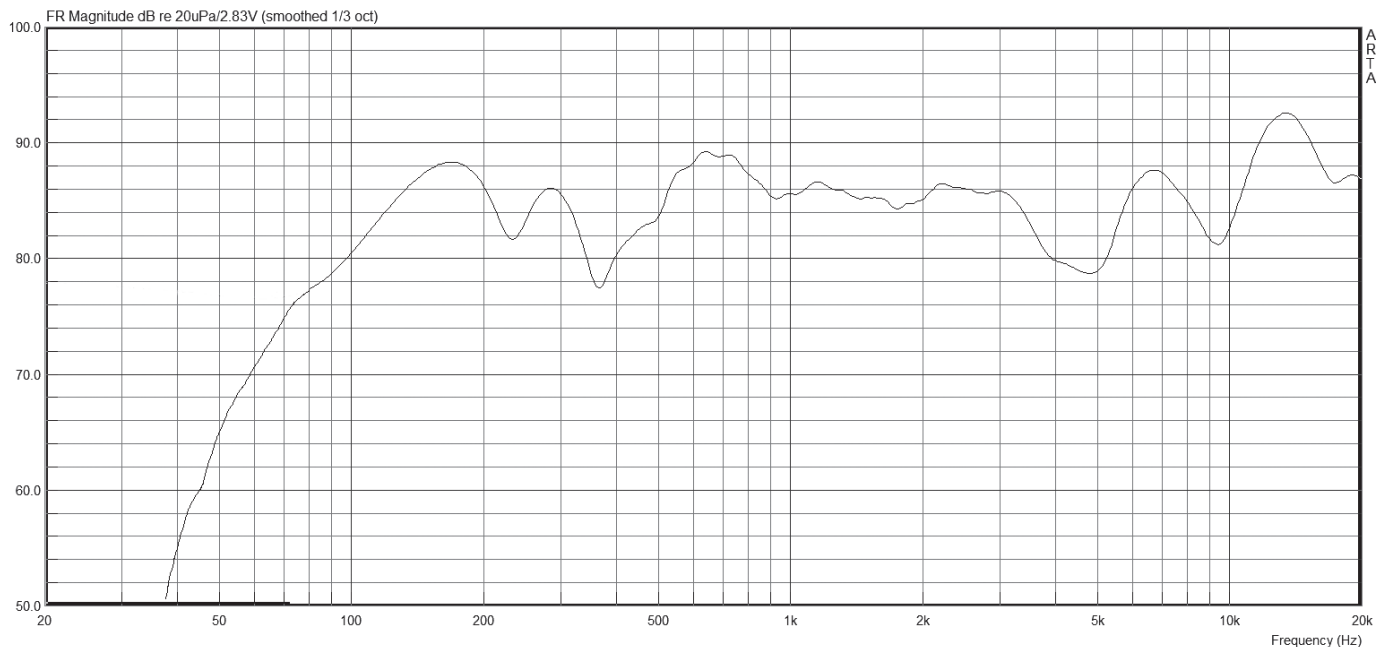

Impedance

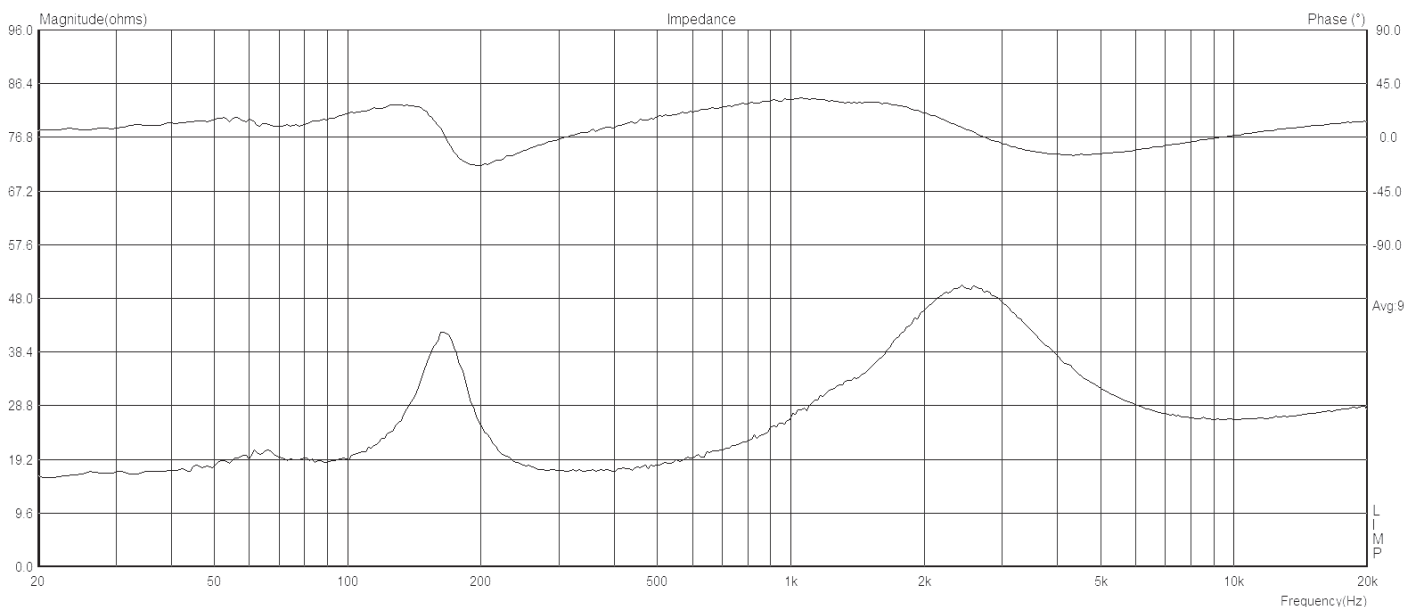

Technical Specifications

Description	4" 2-way surface-mount, U-bracket
Response (f3)	75 Hz -20 kHz
Response (f10)	60 Hz -20 kHz
Impedance	16 ohm
Sensitivity (2.83 V/1 m)	84 dB
Sensitivity (1 W/1 m)	87 dB
Power handling	20 W
Maximum SPL	100 dB
Average coverage angle (2 kHz -10 kHz)	120°
Transformer taps (100 V)	20, 10, 5, 2.5, 1.3 W
Transformer taps (70 V)	20, 10, 5, 2.5, 1.3 W
Transformer taps (25 V)	20, 10, 5, 2.5, 1.3 W
Tweeter	0.75 inch silk dome with phase plug
Woofers	4 inch polypropylene with rubber surround
Acoustic description	Musical, with high intelligibility. A high efficiency speaker optimised for music and paging.
Input	Euroblock
Included accessories	U bracket, male Euroblock, rubber port plug
Optional accessories	n/a
Available colours	Black RAL9011, White RAL9003
Packaging	1 per box
Net weight/Gross weight	2.5 kg (5.5 lb) / 3.2 kg (7 lb)
Bracket mounting hole spacing	143.5 mm / 5.65 in
Conformance	UL1480 / 2043 planned, RoHS, CE approved, IP55

Architect's and Engineer's Specification

The loudspeaker shall consist of one moulded ABS enclosure containing two transducers, a frequency dividing network, a transformer, and acoustic damping material. It shall be rated as an IP55 compliant loudspeaker when fitted with a supplied port plug. It shall incorporate an integrated mounting system including U-bracket. It shall include one removable aluminium grille affixed to the baffle. The grille shall include a removable logo tab.

The loudspeaker shall include one 101.6 mm (4.0 inch) low-frequency transducer in a ported enclosure. The low frequency voice coil diameter shall be 19.5 mm (0.75 inch). The low-frequency transducer shall have a polypropylene cone material with a rubber surround. The high-frequency transducer shall incorporate a silk dome.

The loudspeaker shall include a 20 watt transformer with taps at 20 W, 10 W, 5 W, 2.5 W and 1.3 W. Said taps shall be selected via an included tap switch located on the front baffle, under the removable grille. The transformer shall accept 25 V, 70.7 V, or 100 V. The tap switch shall also include a transformer bypass position, allowing for direct connection to the 16 ohm low impedance circuit.

Nominal performance specifications shall be as follows: The loudspeaker shall have a usable frequency range extending from 60 Hz - 20 kHz (-10 dB). The nominal impedance shall be 16 ohms, and the maximum continuous RMS power handling shall be at least 20 W according to the EIA-426-B standard. Sensitivity measured at 2.83 V / 1 m shall be 84 dB. The maximum output at 1 m shall be 100 dB.

Installation for the speaker shall be with U-bracket and shall attach to the wall. The external wiring shall be via 4-position 5.08mm Euroblock connector, accepting up to 10 gauge wire. The maximum overall height shall be no more than 296.30 mm (11.66 inches) and the maximum depth shall be no more than 184.07 mm (7.25 inches). The unit is factory preset to the 20-watt setting in the 100 volt operating mode, with a tap switch located on the front baffle.

The system shall be the Cloud CS-S4 for both low- and high- impedance applications.